



Prolift SCL Prolift HD

ACCESSIBILITY LIFTS

Planning Guide

Applicable Codes:

ASME A18.1-2008 Section 2

CAN/CSA B355 - M00, B355S1-02, B355-09

Part No. 000781
23-m06-2011

© 2011 Savaria Corporation

Purpose of this guide

This planning guide is designed to assist architects, contractors and lift professionals in planning for a Prolift SCL or Prolift HD Wheelchair Lift to meet the requirements of the following codes:

- ASME A18.1-2008 Section 2
- CAN/CSA B355 M00
- B355S1-02
- B355-09

We strongly recommend that you contact the code authority having jurisdiction in the area where the lift will be installed to become familiar with all the legal requirements governing the installation and use of lifts in commercial applications. It is extremely important for you to know and adhere to all regulations pertaining to the installation and use of lifts.

How to use this guide

- 1 Determine your client's intended use of the lift.
- 2 Determine the local code requirements.
- 3 Determine the site installation parameters.
- 4 Determine the cab type and hoistway size requirements.
- 5 Plan for machine room and electrical requirements.

IMPORTANT NOTICE

This planning guide provides nominal dimensions and specifications useful for the initial planning of a lift project. Before beginning actual construction, be sure to receive the installation (shop) drawings customized with specifications and dimensions for your specific project.

Lift configurations and dimensions are in accordance with our interpretation of the standards set forth by ASME A18.1-2008 Section 2, CAN/CSA B355 M00, B355S1-02, and B355-09. Please consult Savaria or the authorized Savaria dealer in your area for more specific information pertaining to your project, including any discrepancy between referenced standards and those of any local codes or laws.

The dimensions and specifications in this planning guide are subject to change (without notice) due to product enhancements and continually evolving codes and product applications.

History

November 17, 2010

- Initial release

December 10, 2010

- Corrected information for "Pit depth required" in table on page 5

December 17, 2010

- Corrected information for "Pit depth required" in table on page 5
- Combined sectional views on page 10
- Corrected drawing on page 15
- Corrected pit details on page 42

January 10, 2011

- Added table for Prolift HD (5 HP pump unit) on page 50

June 23, 2011

- Corrected table on page 50

Product description

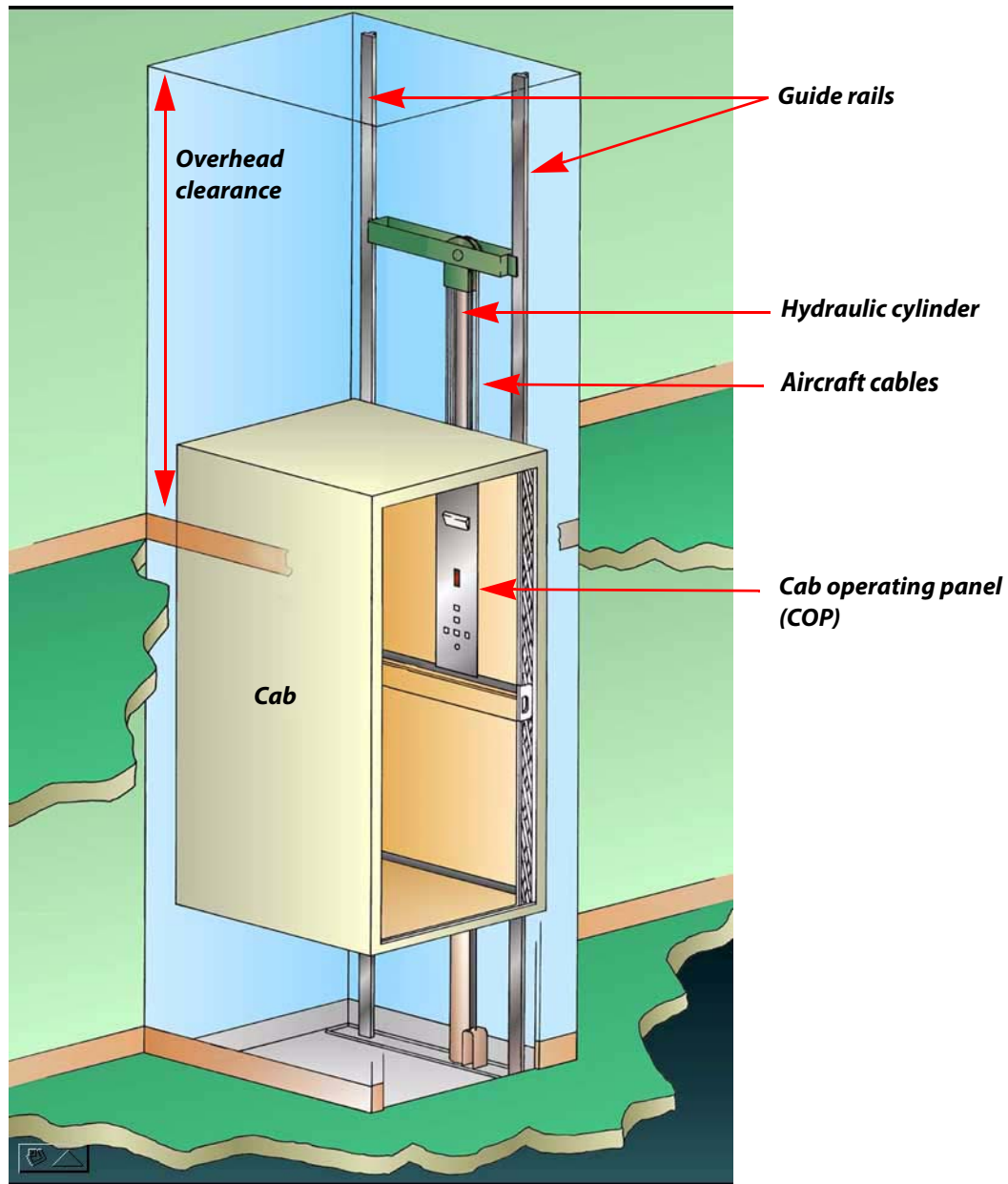

PROLIFT IN HOISTWAY

Meets Americans with Disabilities Act (ADA) requirements

The Prolift SCL and Prolift HD meet the requirements of the ADA Accessibility Guidelines as a means to provide public building access.

Design assistance

With over 30 years of experience, Savaria has the expertise to provide solutions to practically every design challenge you face. Please call our Customer Service Department for professional advice at (800) 661-5112 or (905) 791-5555.

Prolift SCL and Prolift HD specifications

Specification type	Specification data
Load capacity	SCL: 550 lb (250 kg), 750 lb (341 kg), 1000 lb (454 kg) HD: 1400 lb (635 kg)
Rated speed	30 ft/min (0.15 m/s) (nominal)
Power supply NOTE: Amperage may vary depending on individual units. Verify requirements prior to installation of power supply.	208 volt, three-phase, 30 amps, 60 Hz or 230 volt, single-phase, 40 amps, 60 Hz
Drive system	1:2 cable hydraulic
Cab sizes	SCL Type 1L/1R, Type 2, Type 5: <ul style="list-style-type: none"> • 36" x 48" (914 mm x 1219 mm) • 36" x 54" (914 mm x 1372 mm) • 36" x 60" (914 mm x 1524 mm) • 42" x 48" (1067 mm x 1219 mm) SCL Type 3/4, Type 3/4 with 42" B wall opening: <ul style="list-style-type: none"> • 42" x 48" (1067 mm x 1219 mm) HD all cab types (Type 1L/1R, Type 2, Type 3/4, Type 3/4 with 42" B wall opening, Type 5): <ul style="list-style-type: none"> • 42" x 54" (1067 mm x 1372 mm) • 42" x 60" (1067 mm x 1524 mm) • 48" x 60" (1219 mm x 1524 mm)
Maximum travel	CDN: 23 ft (7 m) – confirm with local code US: 14 ft (4.3 m) – confirm with local code
Maximum # of stops	4 stops
Pit depth required	12" (305 mm) minimum
Minimum overhead clearance	92" (2337 mm)
Control system	Constant pressure
Floor selection	Magnetic selector
Flooring material	Plywood
Control panel finish	Stainless steel
Hall station finish	Stainless steel
Motor	SCL: 3 HP (2.24 kW) HD: 5 HP (3.73 kW)
Cab panel finish	Standard solid melamine panels
Lighting supply	115 volt, 60 Hz, 15 amps
Standard features	Anti-creep device Automatic cab on/off lighting Car top stop switch Clear anodized aluminum cab trim Data plates, capacity tags and rope tags Emergency stop and alarm buttons Emergency battery back-up for lighting, alarm and emergency lowering Upper and lower terminal limits Magnetic floor selection, stopping and re-leveling Manual reset slack rope safety switch Mechanical rail shoring blocks Negative pressure switch Pit switch Pump run timer Rail sections (8 ft optional or 16 ft standard) Recessed incandescent down lights Stainless steel handrail Two 12 V, 4 AH, sealed no maintenance batteries with 24 V, 4 amp Smart Charge™ battery charge Unfinished plywood sub-floor Variable speed pressure compensated valve with manual lowering White egg crate ceiling
Options	Cab floor rubber mat Emergency hands-free telephone Hose with flow control valve (15 ft, 20 ft or 25 ft) In car digital floor indicator Interlocks for doors by others Keyed on/off control panel and hall stations Lamp style hall position indicators Light screens Pipe rupture valve Pro manual or pro auto fire rated door with Prolocks Spring buffers (17" pit depth minimum)

Prolift cab types

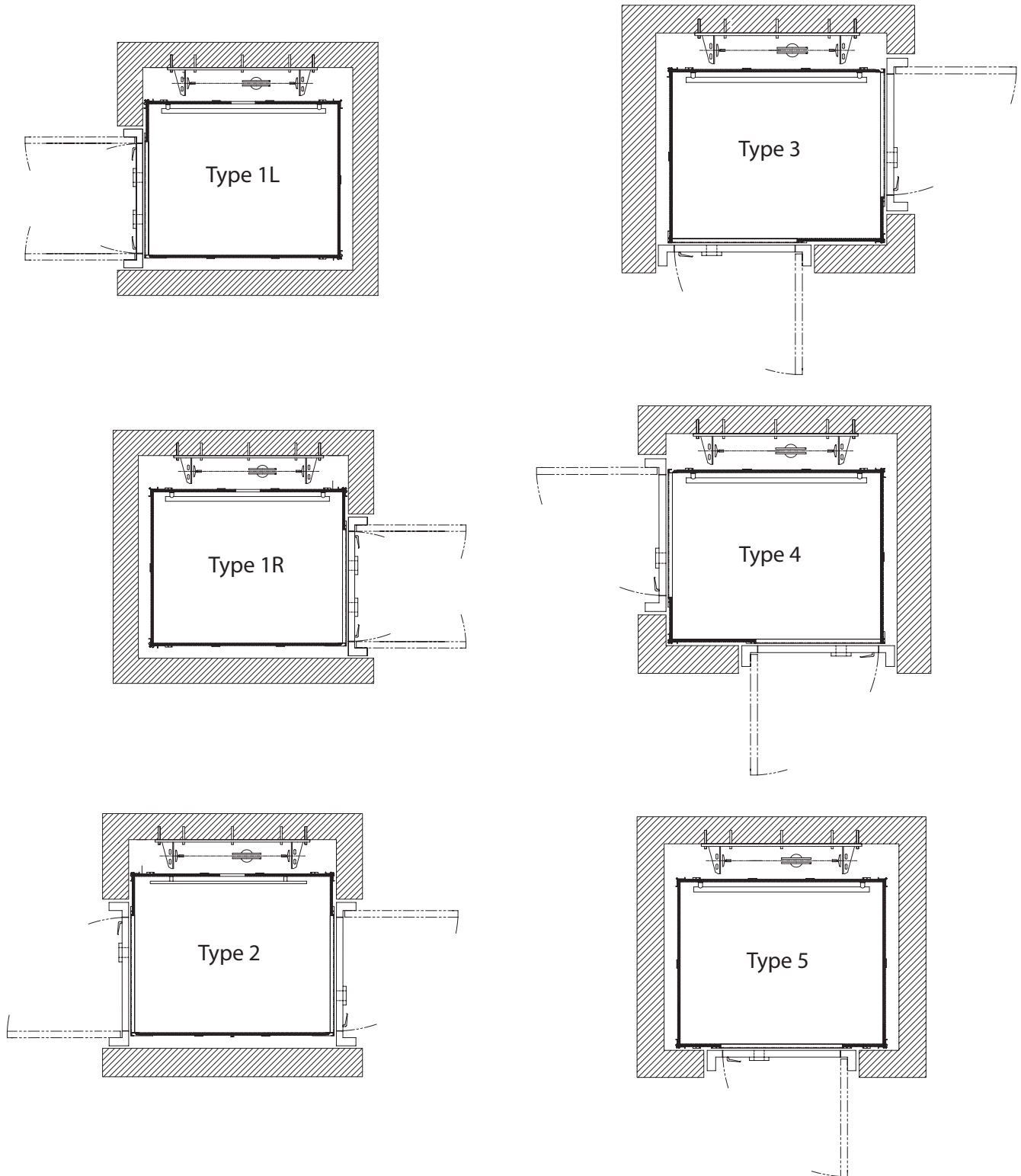

IMPORTANT

Finished hoistway dimensions must include the drywall. Determine the fire rating of the hoistway, the type and layers of sheet rock and build only off the final installation (shop) drawings specific to your project.

Machine room options

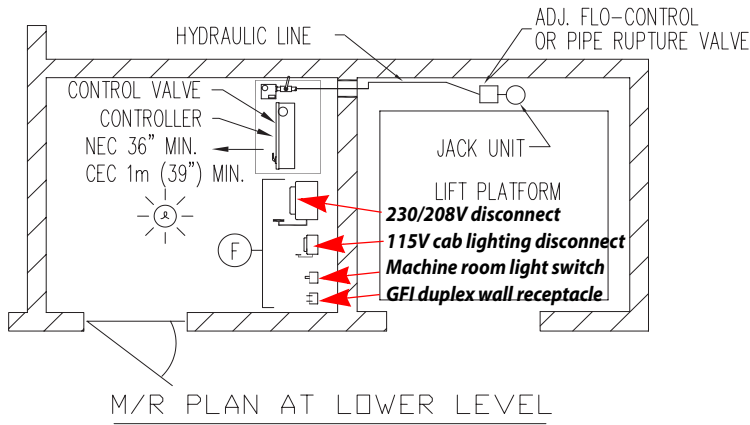

Left-hand position

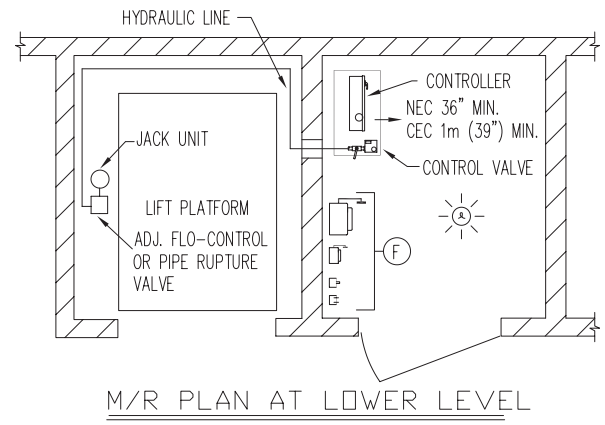

Right-hand position

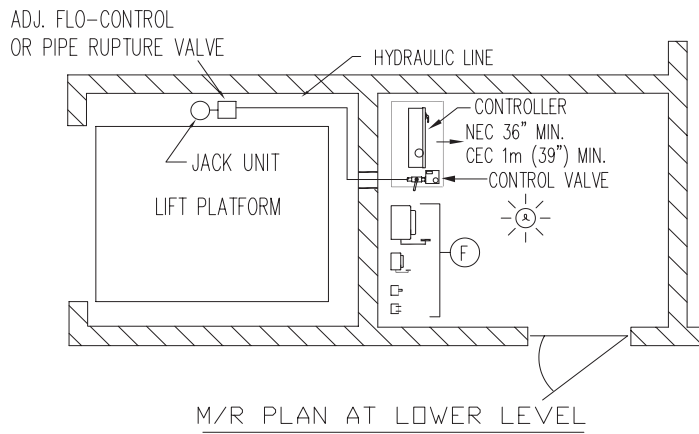

Back position

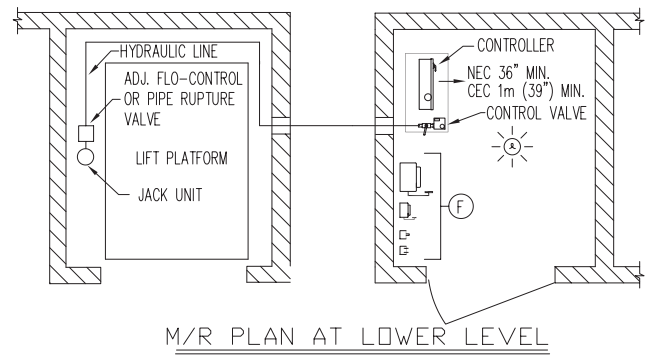

Remote position

- The machine room must be built in accordance with local, state/provincial and national codes. Adequate ventilation is required to maintain a temperature of 50°F to 100°F for output of 3600 BTU per hour.
- Power supply must be 208V three-phase with 30 amp or 230V single-phase with 40 amp dedicated circuit with equipment ground. A lockable fused disconnect with an auxiliary normally open interlock switch must be located next to the controller. The electrical circuit must terminate on the line side terminal lugs of the disconnect. It is provided and installed by others.
- The machine room lighting shall be a minimum of 19 foot candles (204 lux) at working surfaces.
- The switch for the light must be within 18" of the strike side of the machine room door.
- The switch, light and wiring are provided and installed by others. The light must be guarded to prevent accidental breakage of contact with the hot bulb. The switch, light, wiring and guard are provided and installed by others.
- A convenience outlet of 115V single-phase 15 amp with G.F.I. shall be located next to the light switch in the machine room (provided and installed by others).
- NEC requires a 30" wide x 36" deep work space in front of the disconnects and the lift controller.
- A telephone line circuit is to be provided and installed by others. This circuit must be connected to an outside line or a 24 hour central exchange.
- The machine room access door must be self closing, self locking with a key and spring return latch. Door and hardware are provided and installed by others. Consult local building codes for door construction.
- The machine room must be free of any pipes, wiring and obstructions not related to the operation of the lift. Provide a 4 inch conduit from the lift shaft to the remote machine room.

Machine room dimensions

IMPORTANT NOTE:
CONFIRM REQUIREMENTS WITH LOCAL CODE

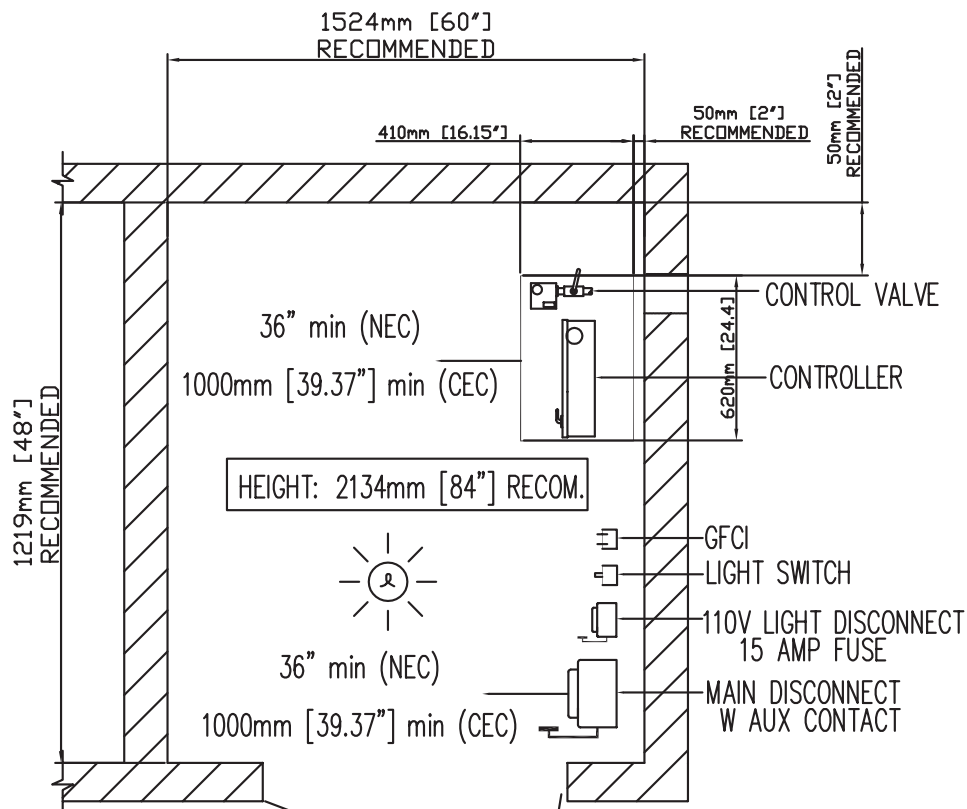

NOTE A:
POSITION OF DOORS AND COMPONENTS CAN VARY
AS LONG AS THE MINIMUM DISTANCE IN FRONT OF COMPONENTS IS RESPECTED

NOTE B:
A RACEWAY BETWEEN THE MACHINE ROOM AND HOISTWAY WILL NEED TO BE PROVIDED.
CONSULT YOUR INSTALLATION COMPANY FOR SIZE AND LOCATION

Controller tank specifications

Controller tank specifications	
Dimensions (inches)	H 47" x W 28" x D 17"
Minimum required clearance (inches)	39.37" (1000 mm)
Valve and manual lowering handle location	Inside tank
Rupture valve test	T-fitting factory installed
Tank to controller wiring	Quick connect valve and motor wiring
Controller layout	Relay board
Keyed lock to tank	Yes
Machine room required	No (with local jurisdiction approval)
Tank capacity (gal/ltr)	15-16.5 gal/57-63 ltr
Maximum dry weight (lb/kg)	147 lbs/55 kg
Maximum filled weight (lb/kg)	312 lbs/117 kg
Operating environment	50°F - 120°F / 10°C - 49°C
Operating volume	57 dBA

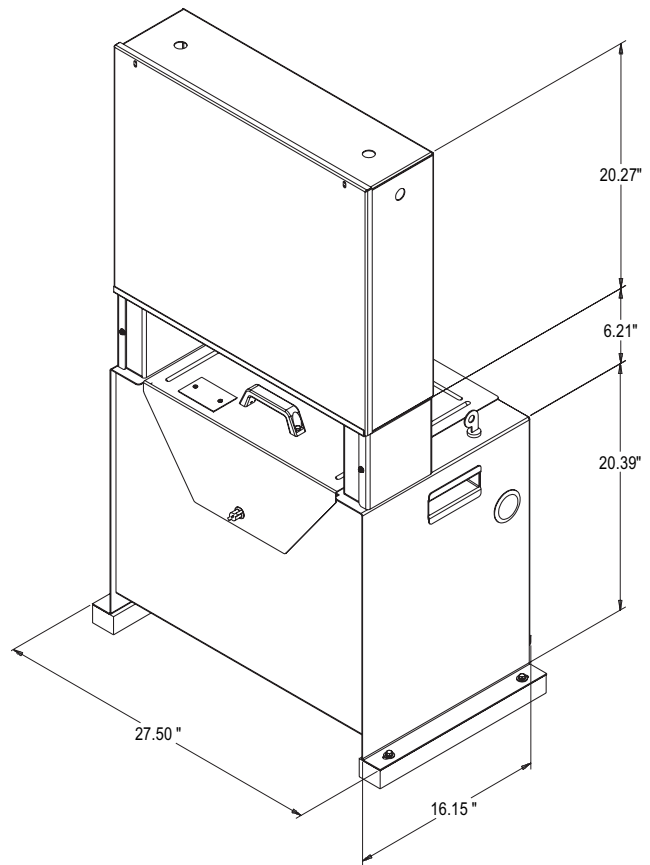

Controller tank features

- Hydraulic hose connection port on both sides of the tank
- Built-in handles on both sides of the tank
- Isolation mounting of pump motor valve assembly minimizes operating issues

Sectional view – Prolift

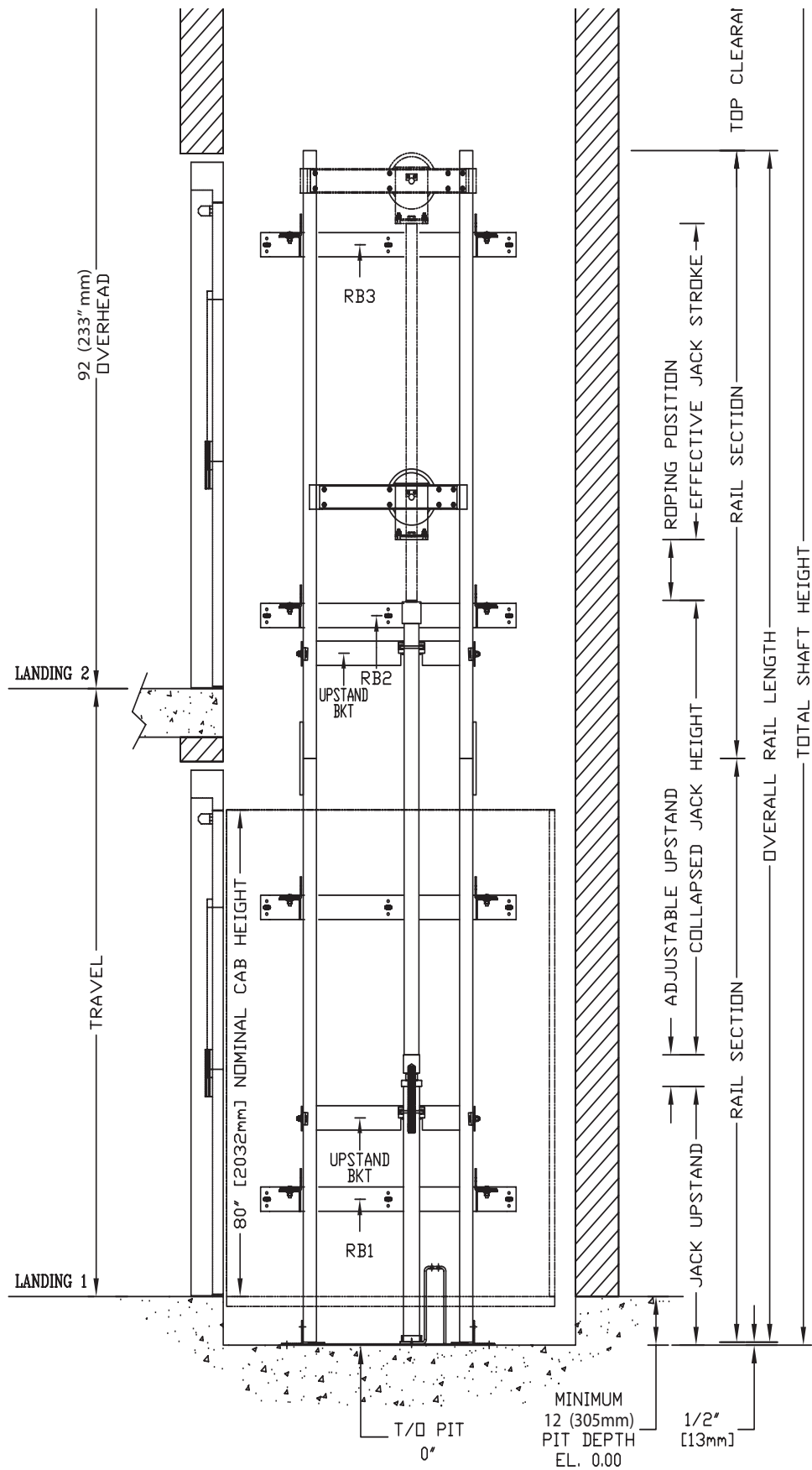

Plan view – Prolift SCL type 1 left-hand (36" x 48", 36" x 54", 36" x 60")

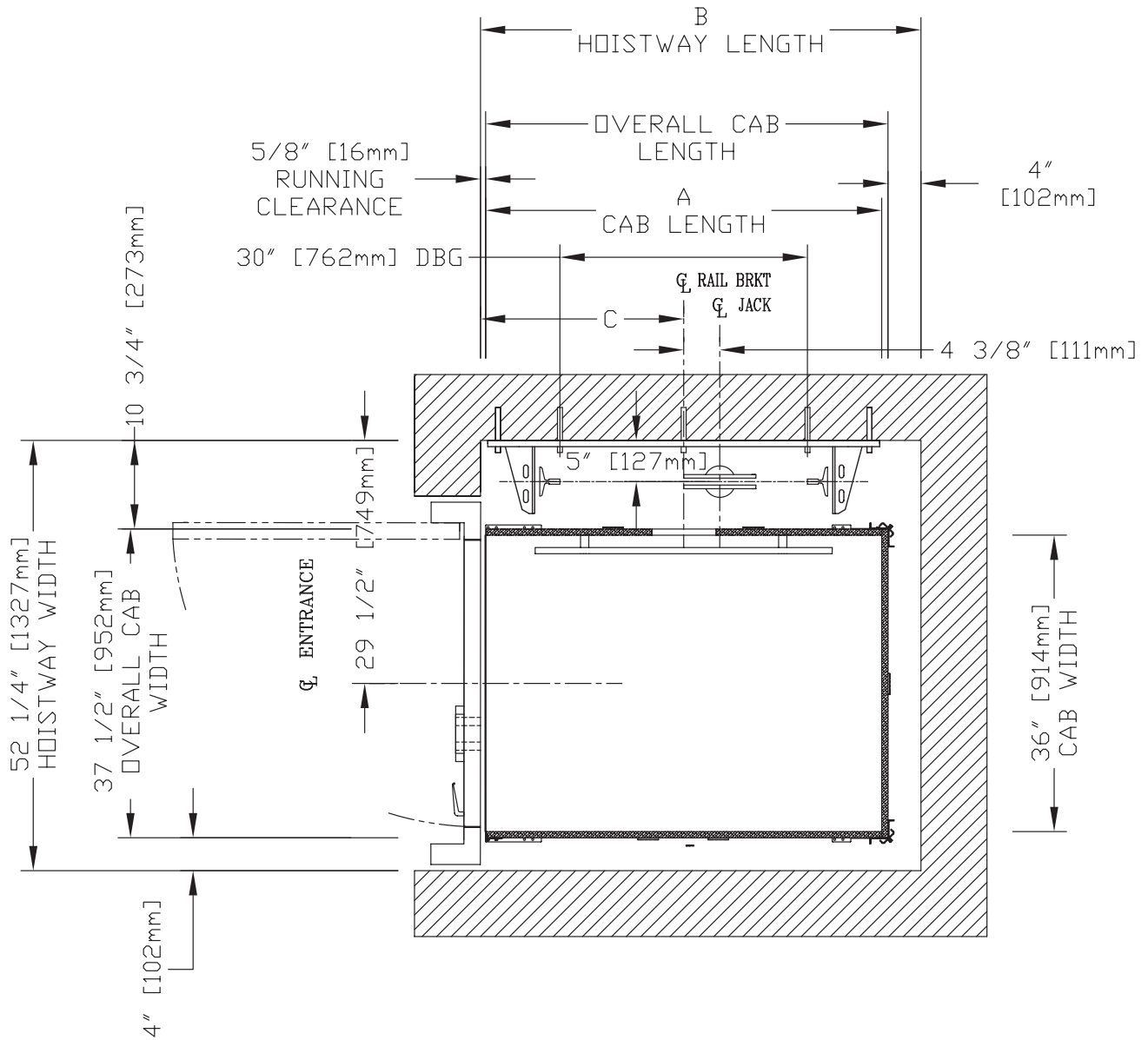

HOISTWAY DIMENSIONS

A CAB LENGTH		B HOISTWAY LENGTH		C RAIL BRKT CENTER LINE	
mm	Inches	mm	Inches	mm	Inches
1219	48	1356	53 3/8	635	25
1372	54	1508	59 3/8	711	28
1524	60	1661	65 3/8	787	31

Plan view – Prolift SCL type 1 left-hand (42" x 48")

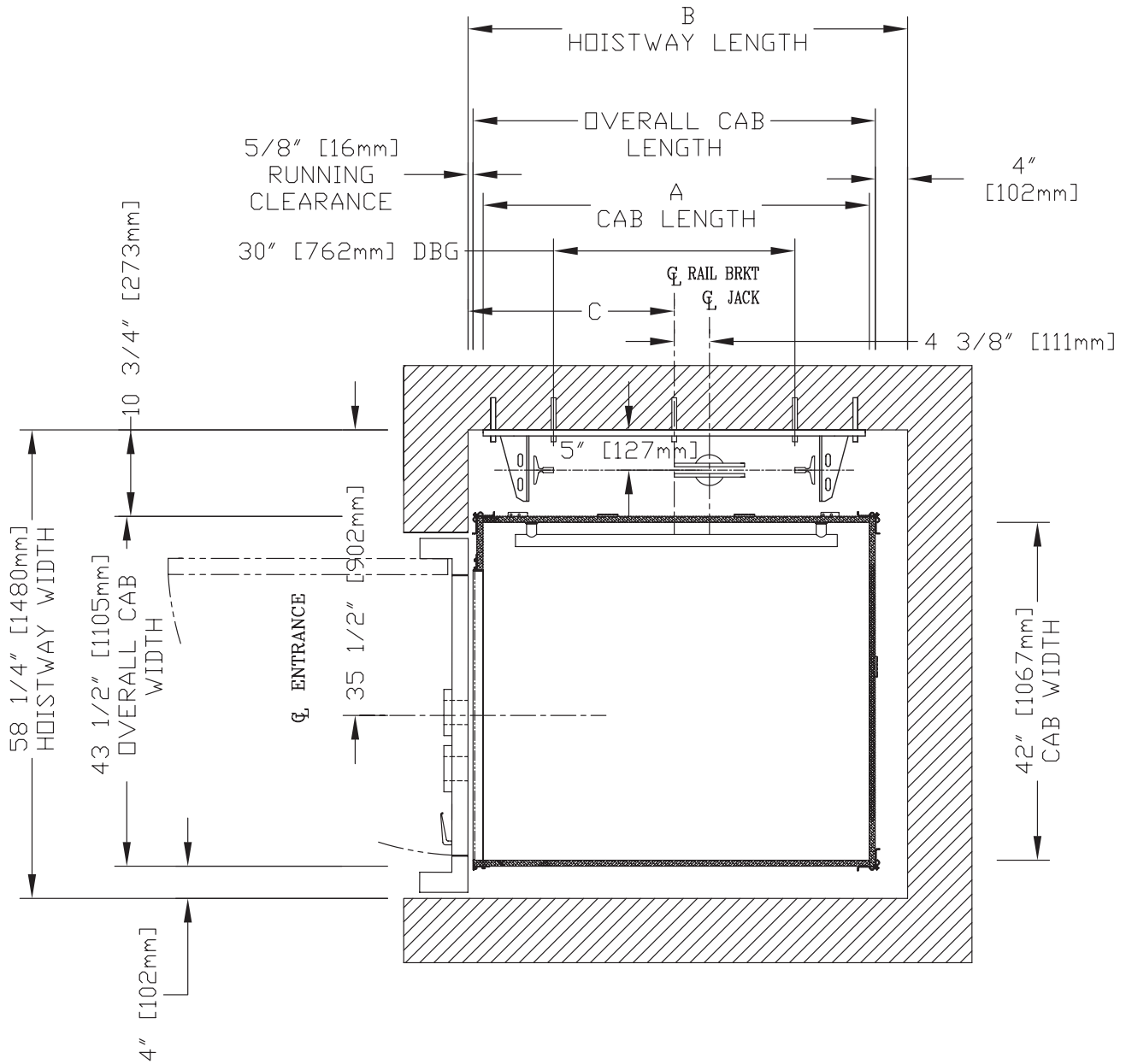

HOISTWAY DIMENSIONS

A CAB LENGTH		B HOISTWAY LENGTH		C RAIL BRKT CENTER LINE	
mm	Inches	mm	Inches	mm	Inches
1219	48	1387	54 5/8	651	25 5/8

Plan view – Prolift SCL type 1 right-hand (36" x 48", 36" x 54", 36" x 60")

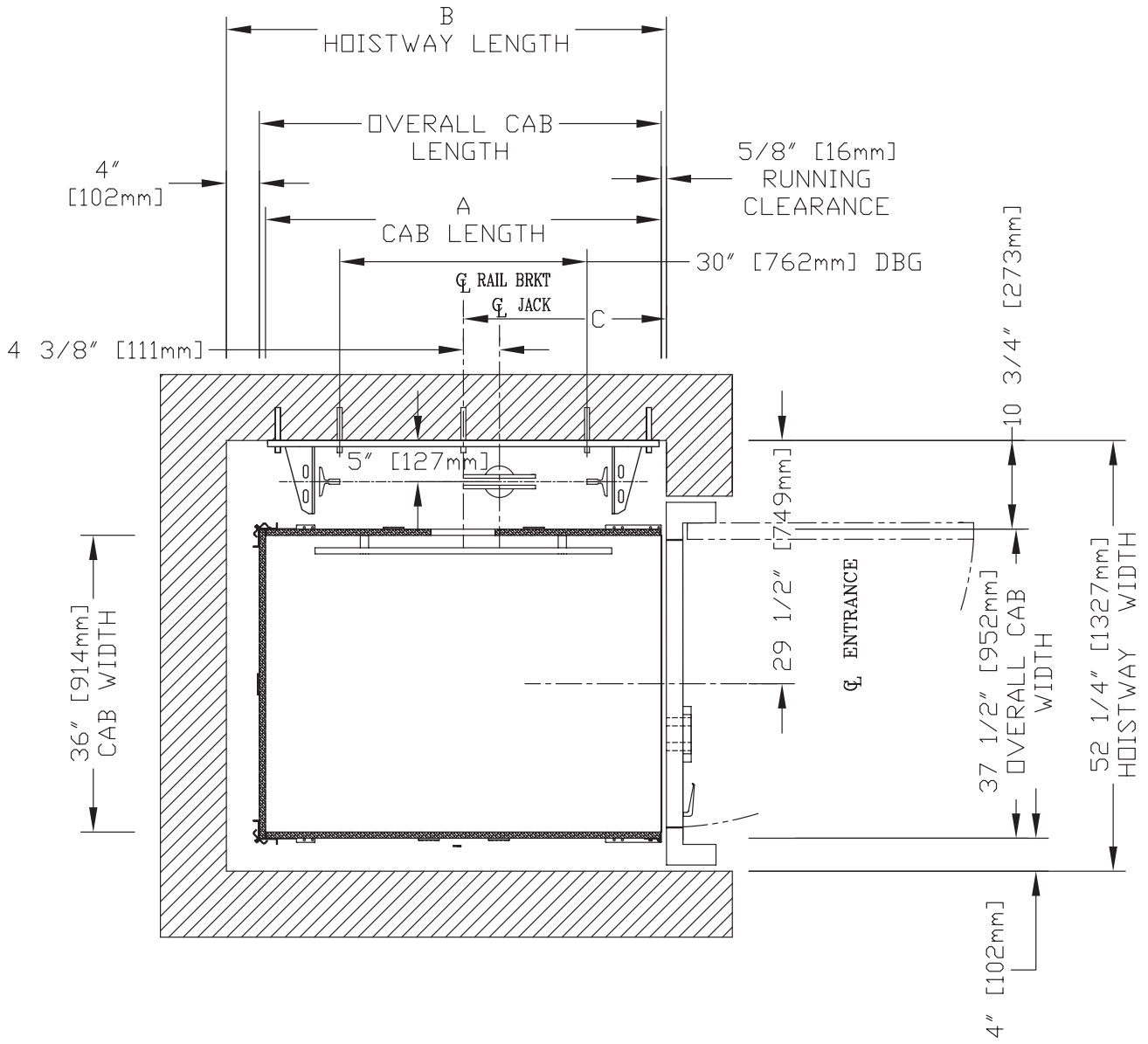

HOISTWAY DIMENSIONS

A CAB LENGTH		B HOISTWAY LENGTH		C RAIL BRKT CENTER LINE	
mm	Inches	mm	Inches	mm	Inches
1219	48	1356	53 3/8	635	25
1372	54	1508	59 3/8	711	28
1524	60	1661	65 3/8	787	31

Plan view – Prolift SCL type 1 right-hand (42" x 48")

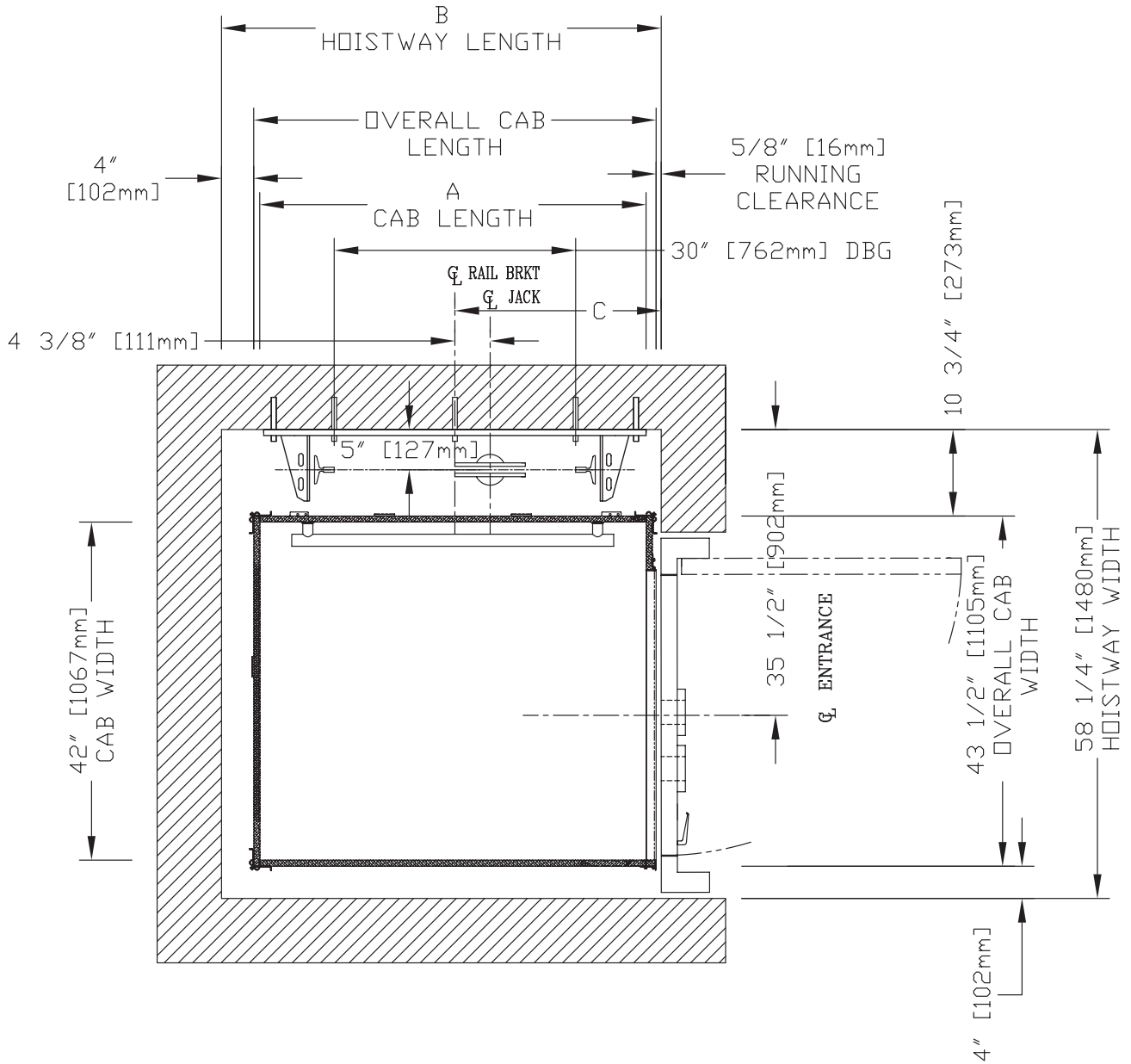

HOISTWAY DIMENSIONS

A CAB LENGTH		B HOISTWAY LENGTH		C RAIL BRKT CENTER LINE	
mm	Inches	mm	Inches	mm	Inches
1219	48	1387	54 5/8	651	25 5/8

Plan view – Prolift SCL type 2 (36" x 48", 36" x 54", 36" x 60")

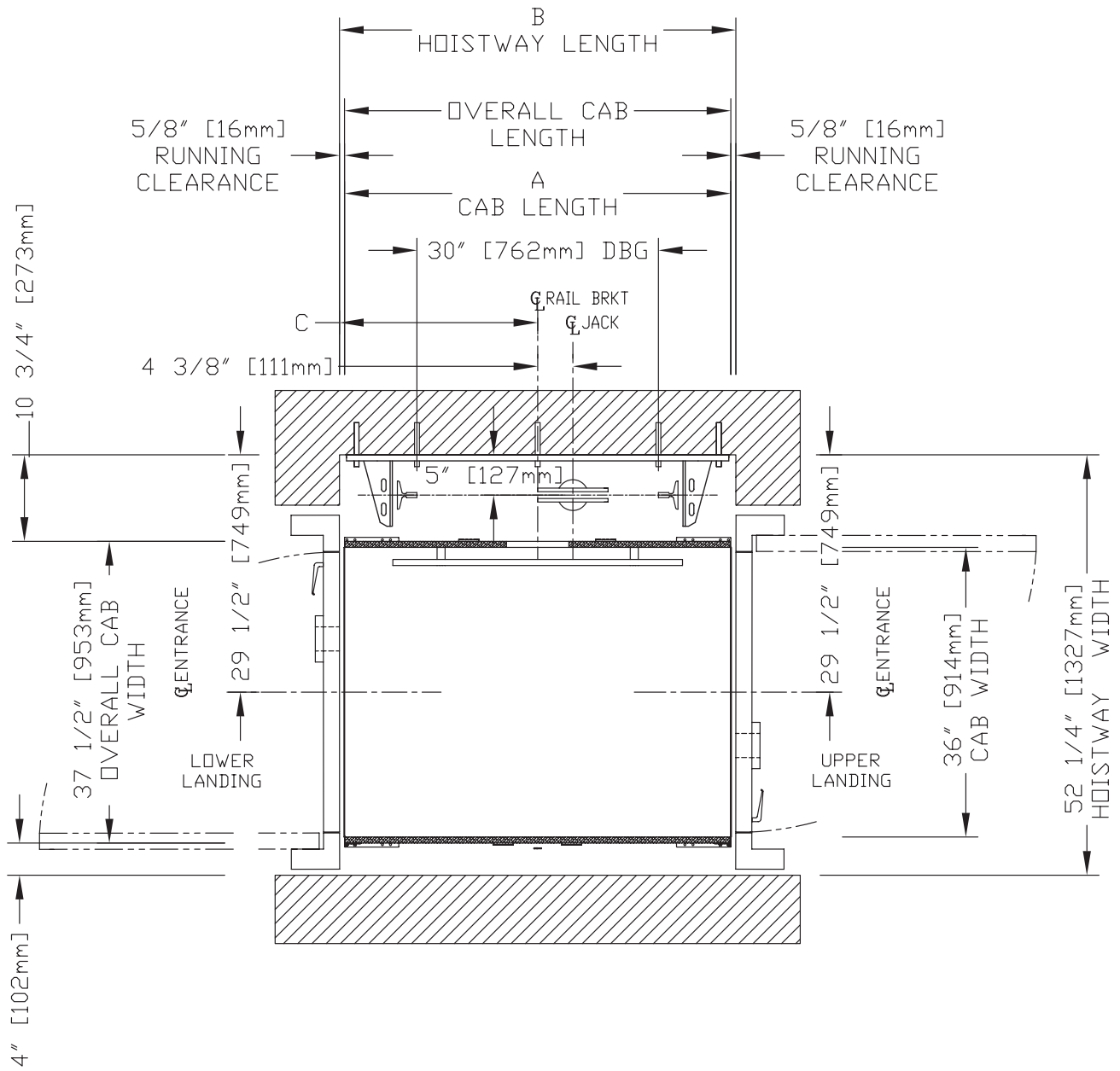

HOISTWAY DIMENSIONS

A CAB LENGTH		B HOISTWAY LENGTH		C RAIL BRKT CENTER LINE	
mm	Inches	mm	Inches	mm	Inches
1219	48	1251	49 1/4	625	24 5/8
1372	54	1403	55 1/4	702	27 5/8
1524	60	1556	61 1/4	778	30 5/8

Plan view – Prolift SCL type 2 (42" x 48")

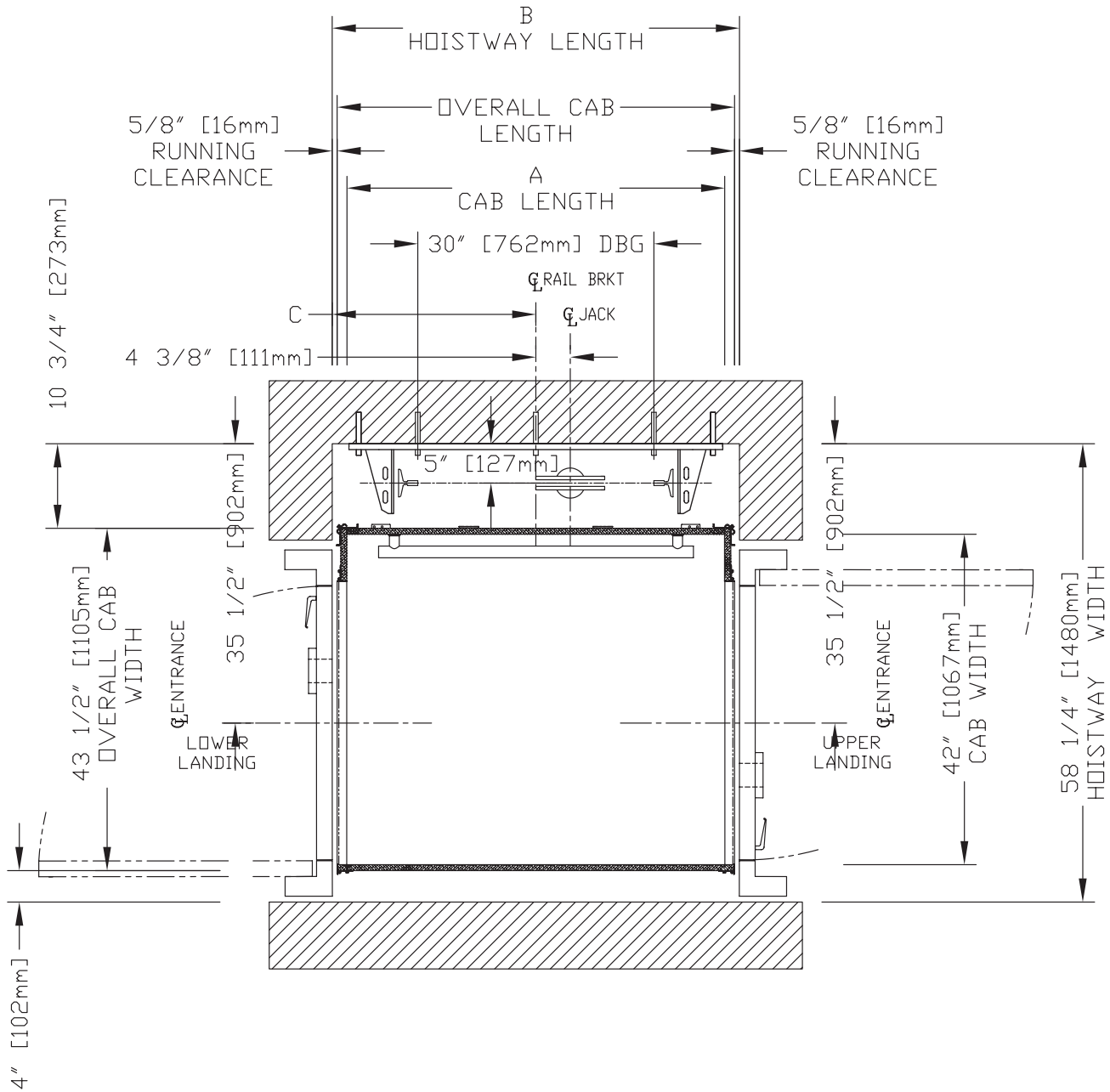

HOISTWAY DIMENSIONS

A CAB LENGTH		B HOISTWAY LENGTH		C RAIL BRKT CENTER LINE	
mm	Inches	mm	Inches	mm	Inches
1219	48	1314	51 3/4	657	25 7/8

Plan view - Prolift SCL type 3 (42" x 48")

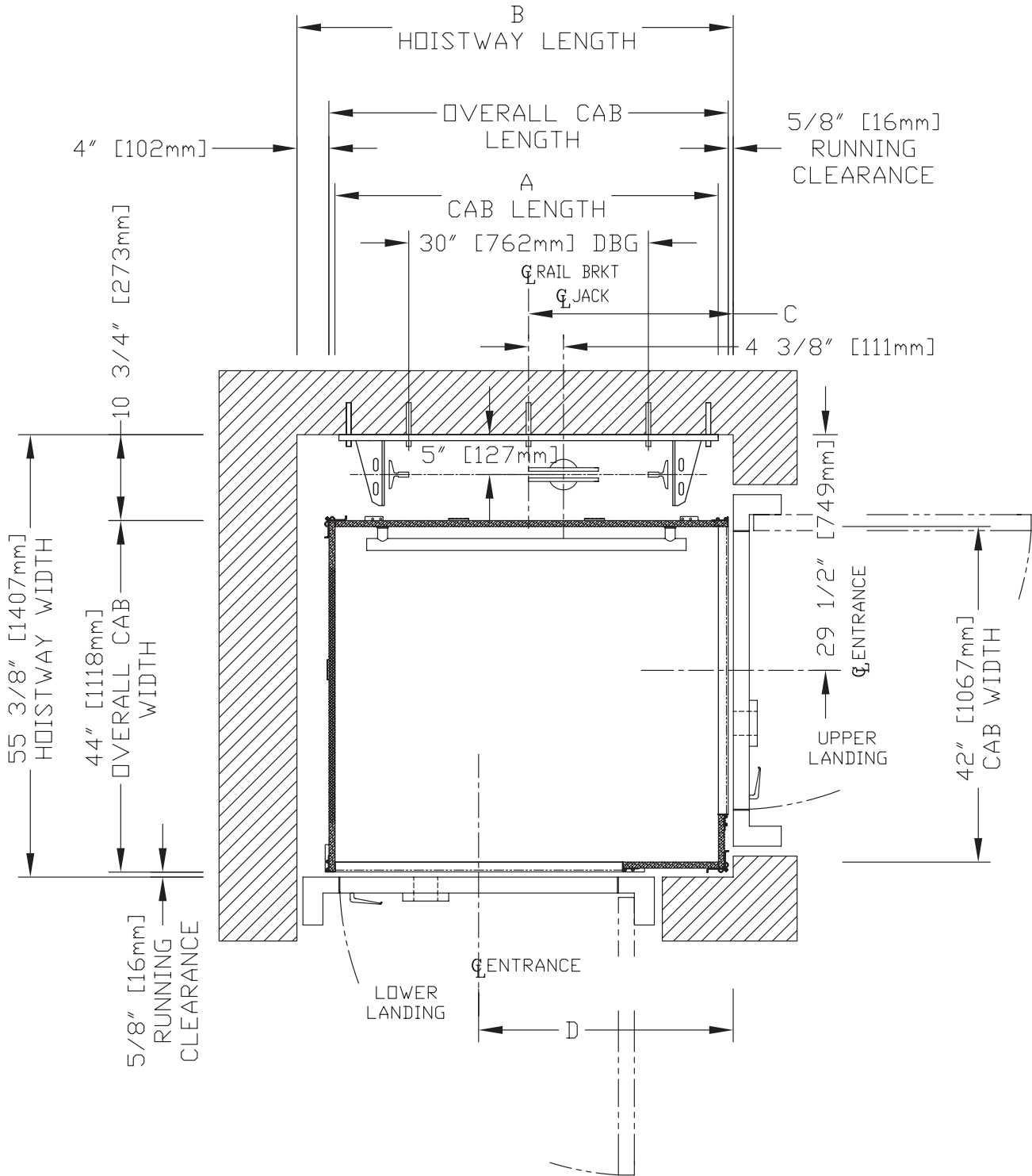

HOISTWAY DIMENSIONS

A CAB LENGTH		B HOISTWAY LENGTH		C RAIL BRKT CENTER LINE		D ENTRANCE CENTER LINE	
mm	Inches	mm	Inches	mm	Inches	mm	Inches
1219	48	1387	54 5/8	651	25 5/8	810	31 7/8

Plan view – Prolift SCL type 3 – 42” B wall opening (42” x 48”)

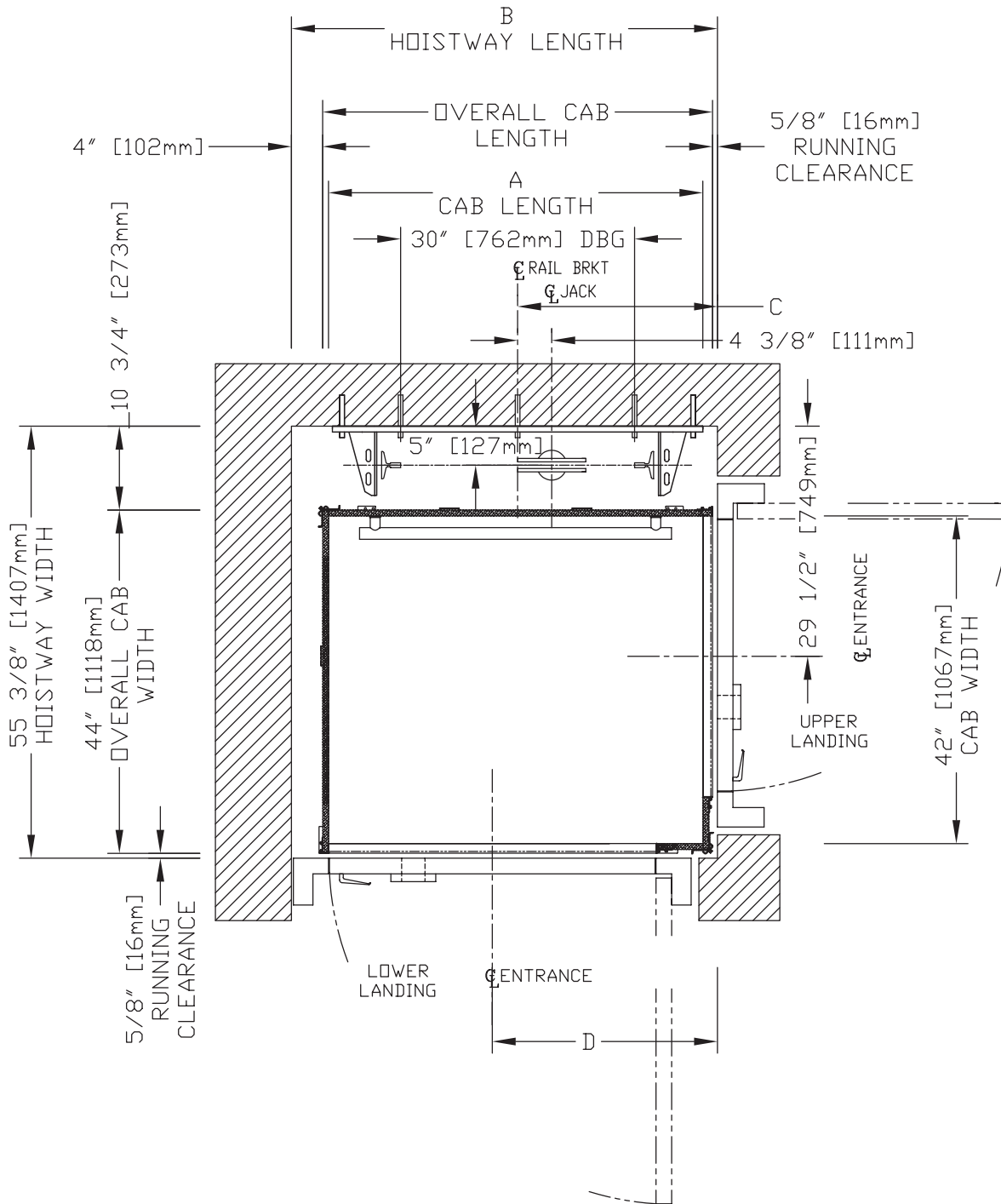

HOISTWAY DIMENSIONS

A CAB LENGTH		B HOISTWAY LENGTH		C RAIL BRKT CENTER LINE		D ENTRANCE CENTER LINE	
mm	Inches	mm	Inches	mm	Inches	mm	Inches
1219	48	1387	54 5/8	651	25 5/8	733	28 7/8

Plan view – Prolift SCL type 4 (42" x 48")

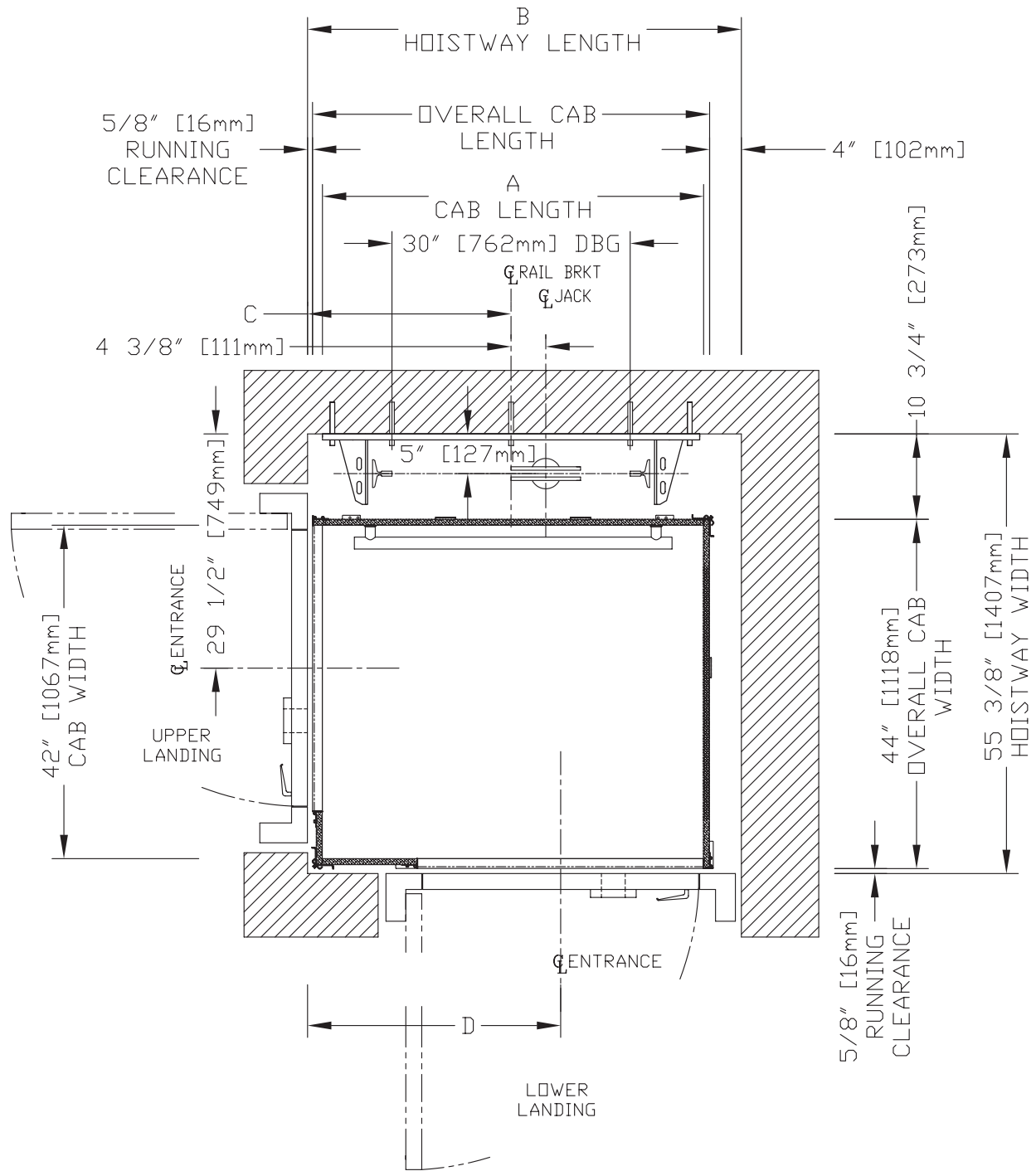

HOISTWAY DIMENSIONS

A CAB LENGTH		B HOISTWAY LENGTH		C RAIL BRKT CENTER LINE		D ENTRANCE CENTER LINE	
mm	Inches	mm	Inches	mm	Inches	mm	Inches
1219	48	1387	54 5/8	651	25 5/8	810	31 7/8

Plan view – Prolift SCL type 4 – 42" B wall opening (42" x 48")

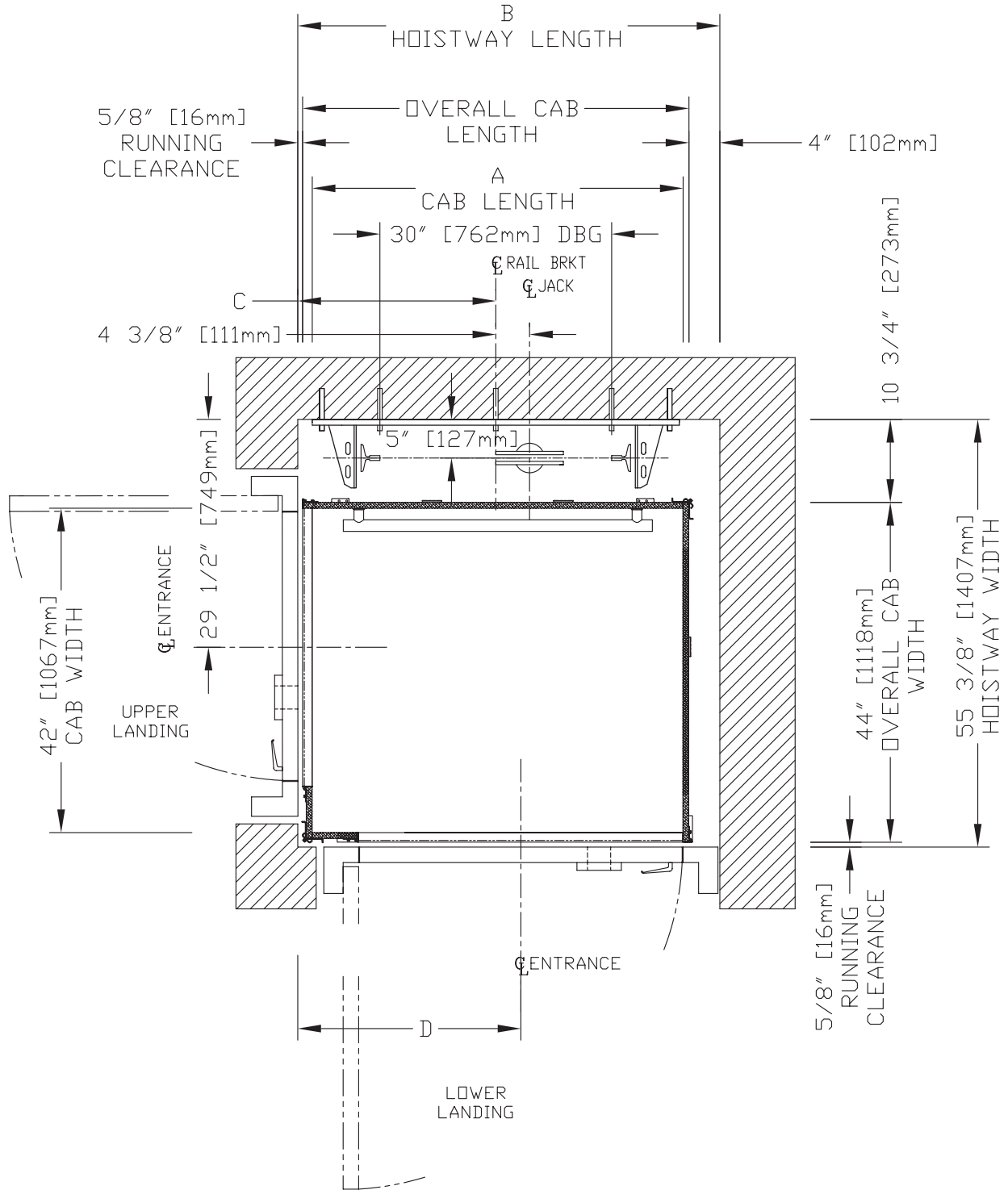

HOISTWAY DIMENSIONS

A CAB LENGTH		B HOISTWAY LENGTH		C RAIL BRKT CENTER LINE		D ENTRANCE CENTER LINE	
mm	Inches	mm	Inches	mm	Inches	mm	Inches
1219	48	1387	54 5/8	651	25 5/8	733	28 7/8

Plan view – Prolift SCL type 5 (36" x 48", 36" x 54", 36" x 60")

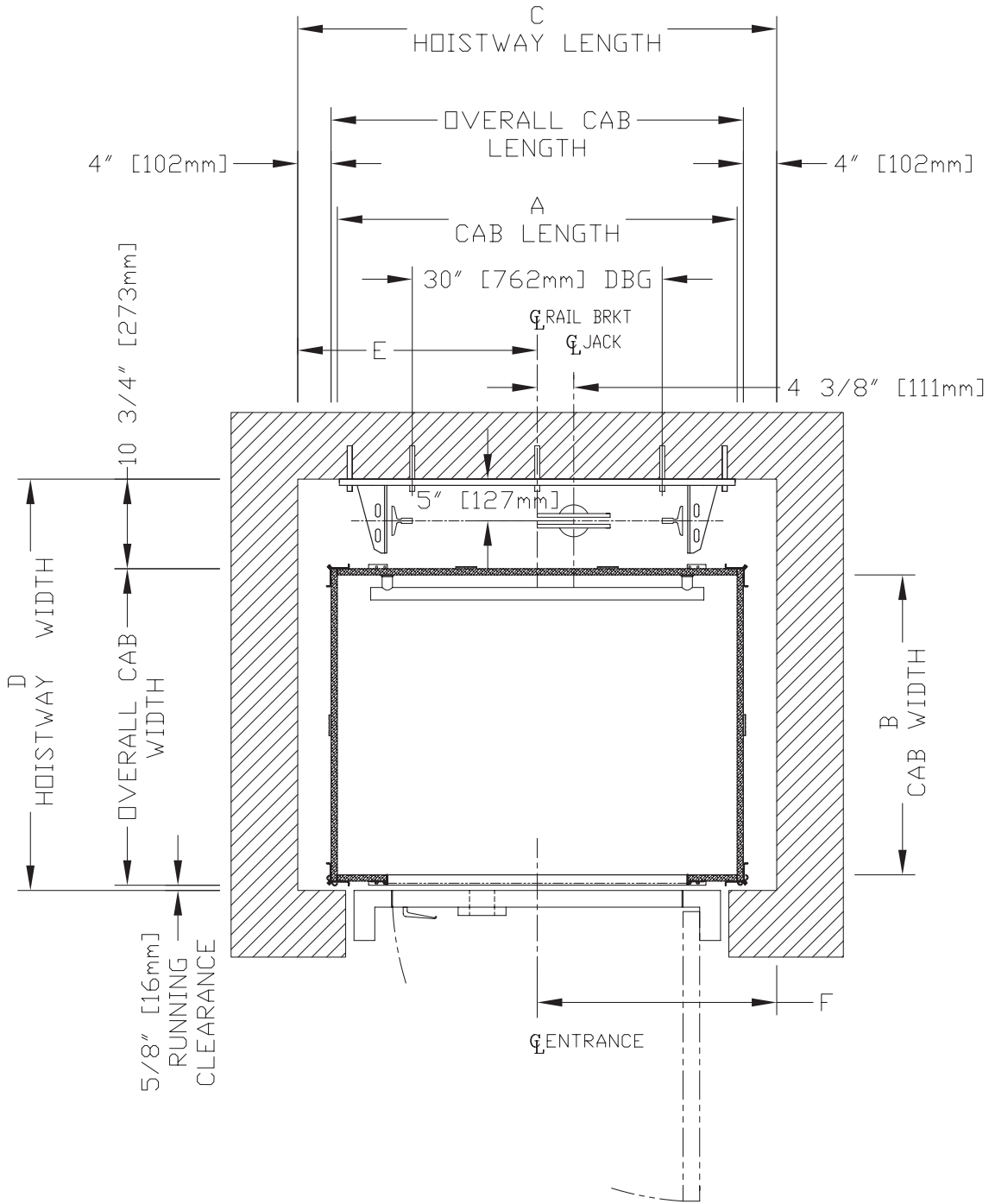

HOISTWAY DIMENSIONS

A CAB LENGTH		B CAB WIDTH		C HOISTWAY LENGTH		D HOISTWAY WIDTH		E RAIL BRKT CENTER LINE		F ENTRANCE CENTER LINE	
mm	Inches	mm	Inches	mm	Inches	mm	Inches	mm	Inches	mm	Inches
1219	48	914	36	1461	57 1/2	1254	49 3/8	730	28 3/4	730	28 3/4
1372	54	914	36	1613	63 1/2	1254	49 3/8	806	31 3/4	806	31 3/4
1524	60	914	36	1765	69 1/2	1254	49 3/8	883	34 3/4	883	34 3/4

Plan view – Prolift SCL type 5 (42" x 48")

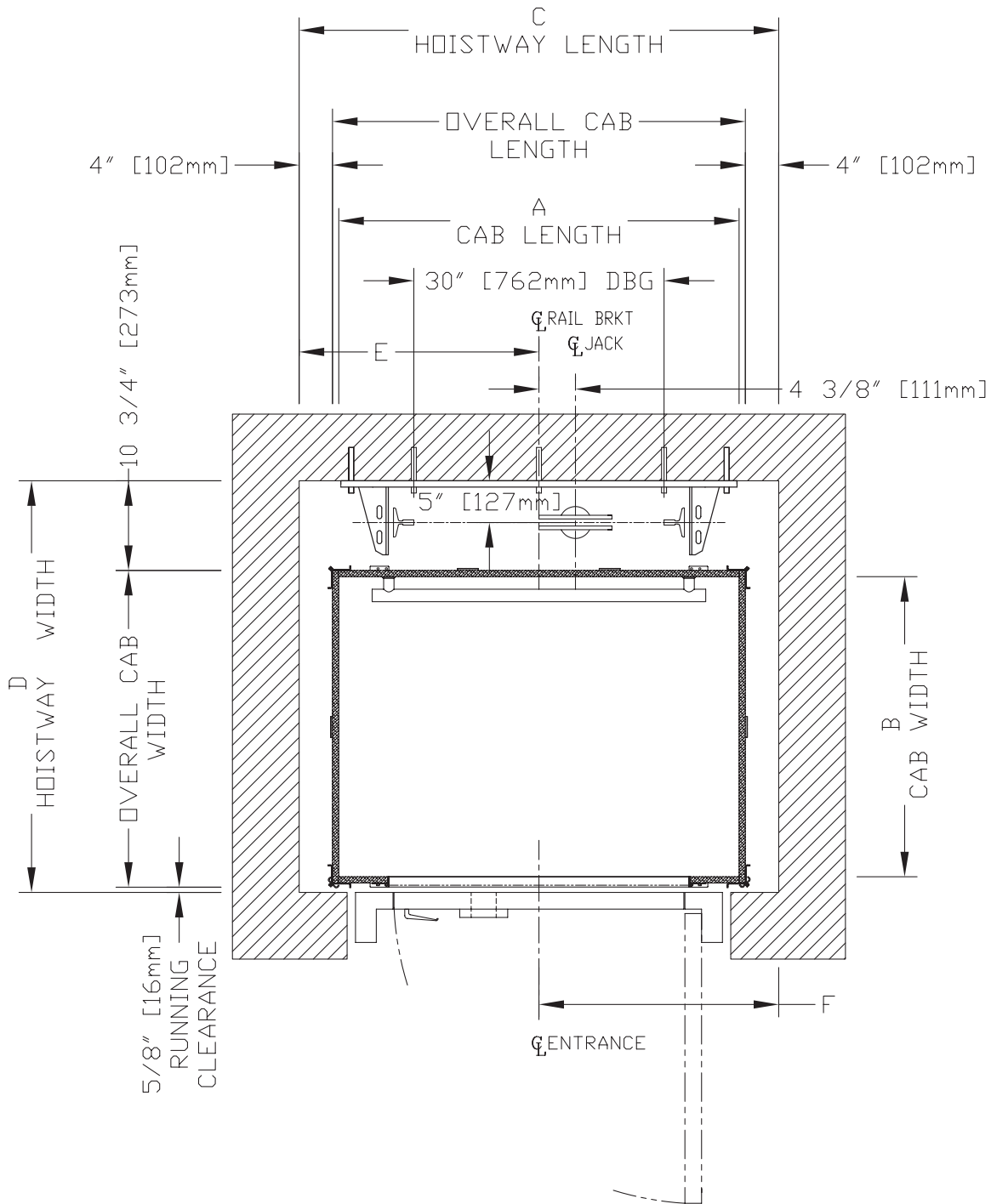

HOISTWAY DIMENSIONS

A CAB LENGTH		B CAB WIDTH		C HOISTWAY LENGTH		D HOISTWAY WIDTH		E RAIL BRKT CENTER LINE		F ENTRANCE CENTER LINE	
mm	Inches	mm	Inches	mm	Inches	mm	Inches	mm	Inches	mm	Inches
1219	48	1067	42	1461	57 1/2	1407	55 3/8	730	28 3/4	730	28 3/4

Plan view – Prolift HD type 1 left-hand (42" x 54", 42" x 60")

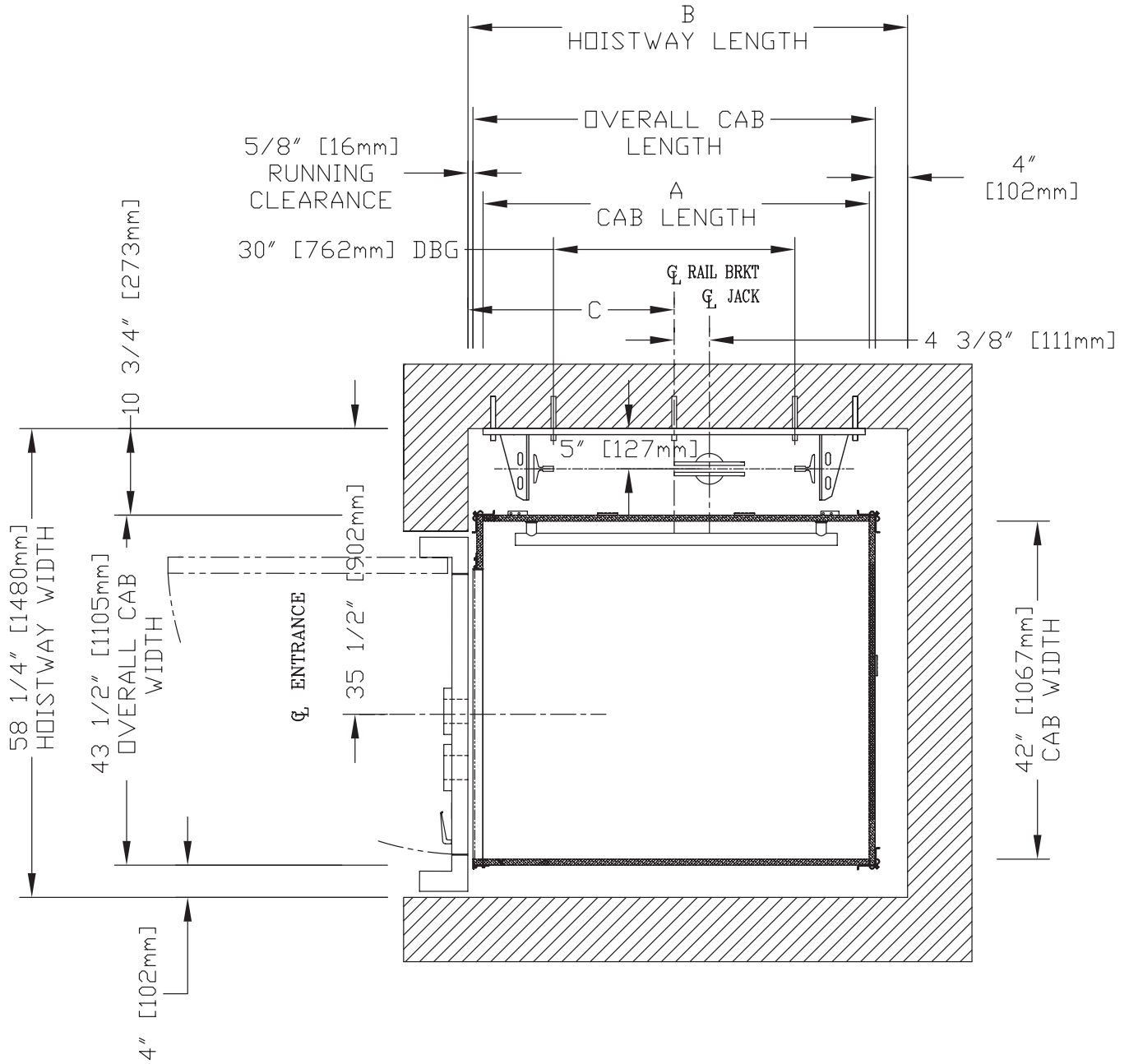

HOISTWAY DIMENSIONS

A CAB LENGTH		B HOISTWAY LENGTH		C RAIL BRKT CENTER LINE	
mm	Inches	mm	Inches	mm	Inches
1372	54	1540	60 5/8	727	28 5/8
1524	60	1692	66 5/8	803	31 5/8

Plan view – Prolift HD type 1 left-hand (48" x 60")

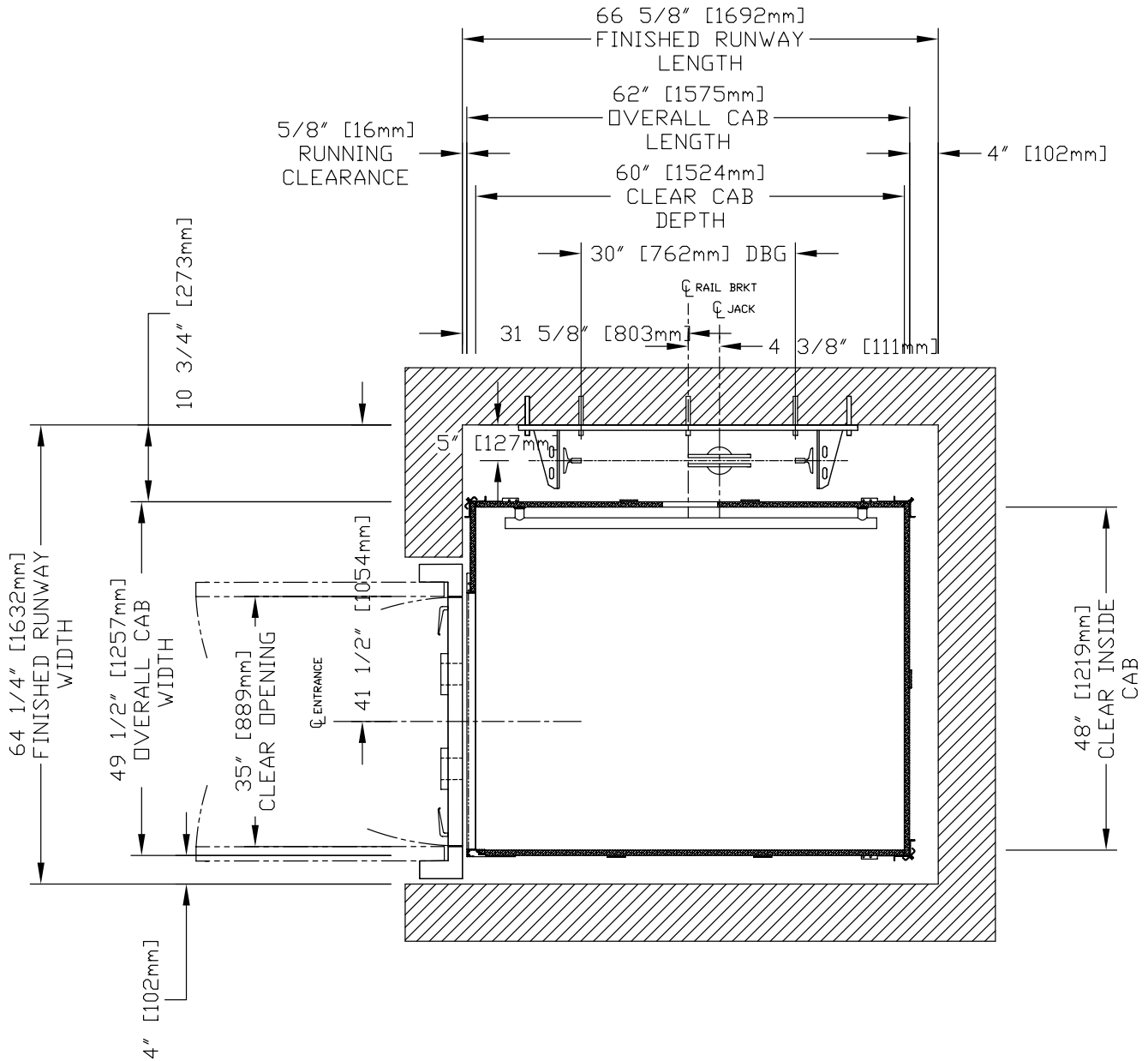

Plan view – Prolift HD type 1 right-hand (42" x 54", 42" x 60")

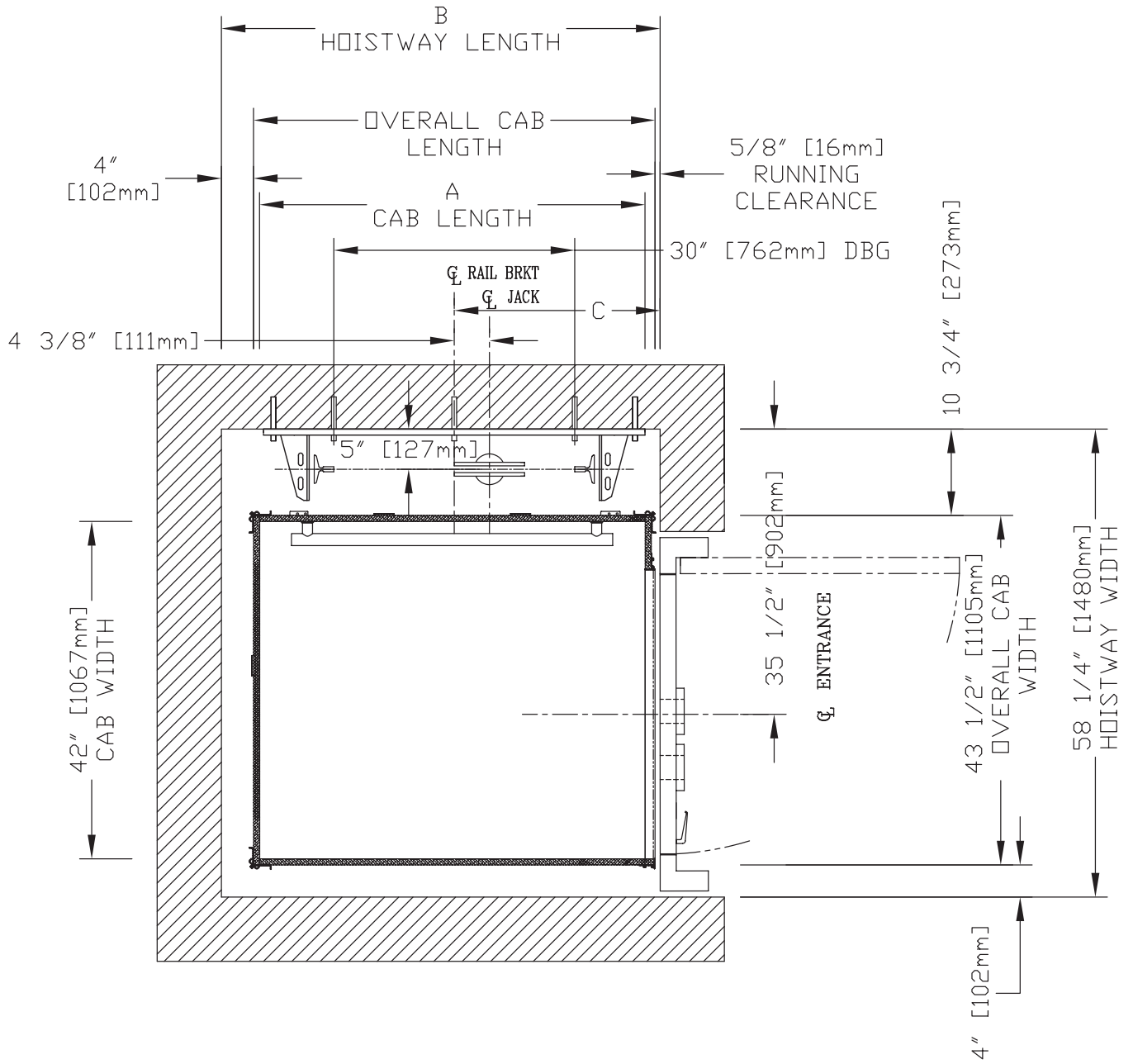

HOISTWAY DIMENSIONS

A CAB LENGTH		B HOISTWAY LENGTH		C RAIL BRKT CENTER LINE	
mm	Inches	mm	Inches	mm	Inches
1372	54	1540	60 5/8	727	28 5/8
1524	60	1692	66 5/8	803	31 5/8

Plan view – Prolift HD type 1 right-hand (48" x 60")

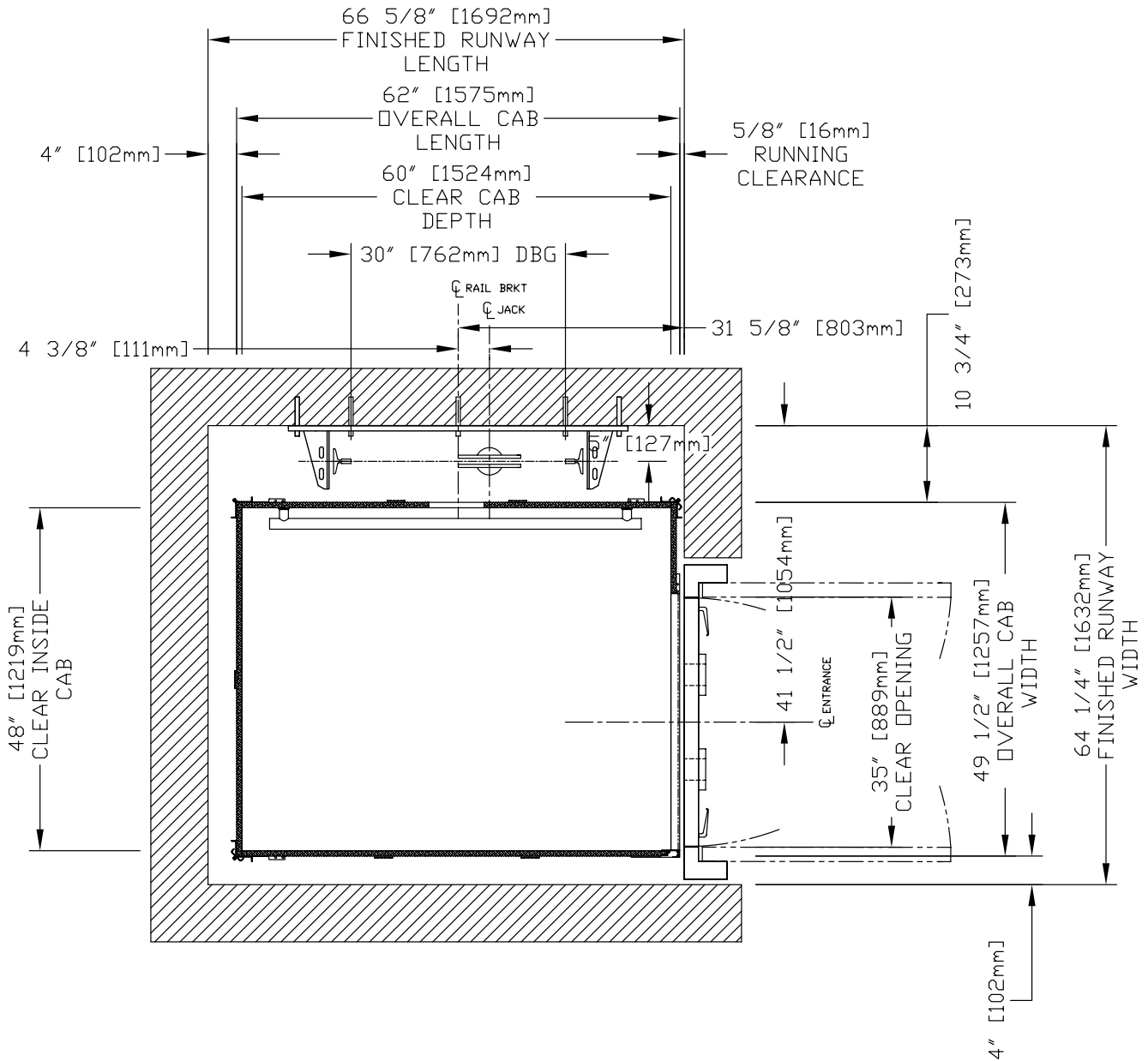

Plan view – Prolift HD type 2 (42" x 54", 42" x 60")

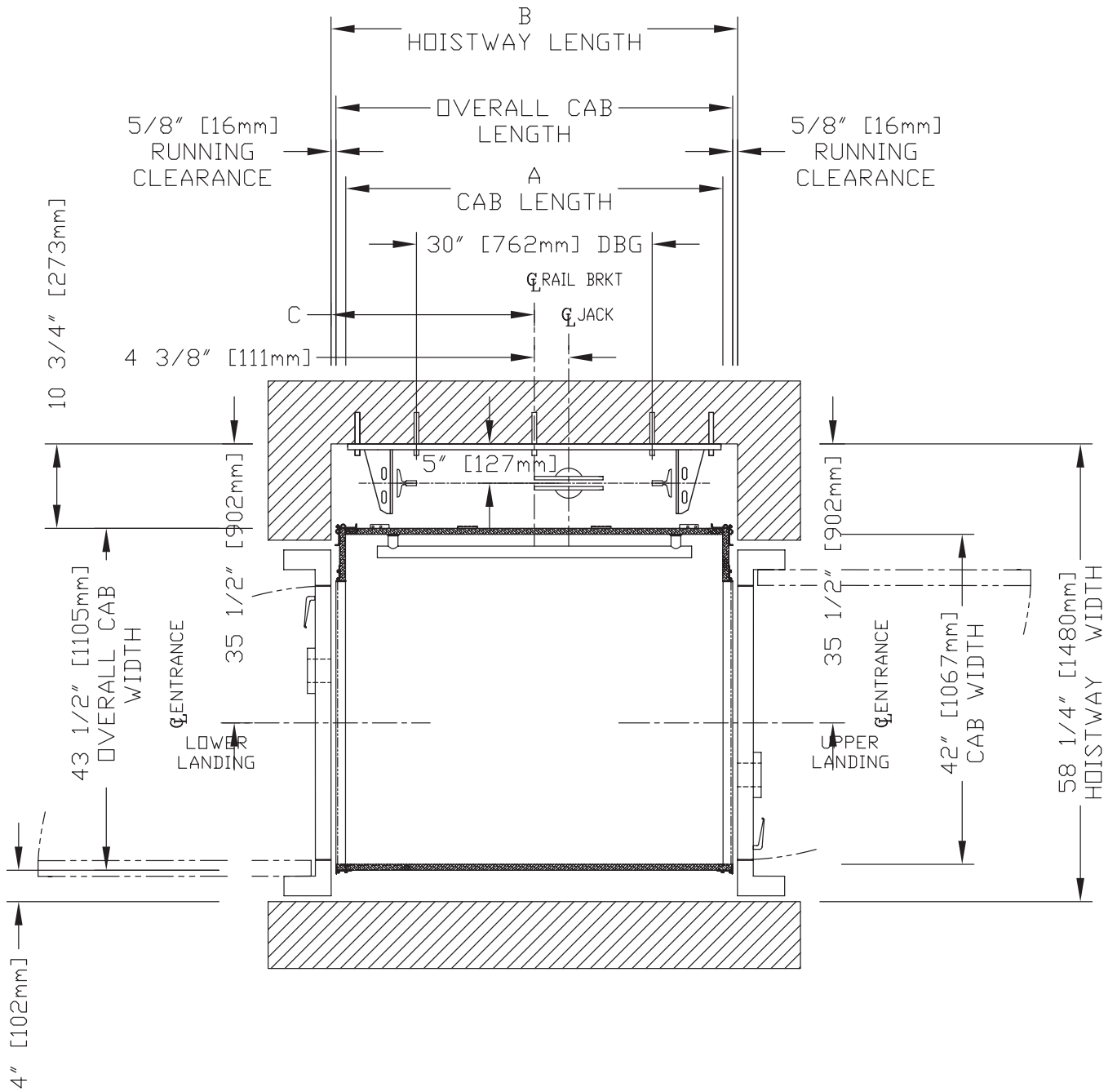

HOISTWAY DIMENSIONS

A CAB LENGTH		B HOISTWAY LENGTH		C RAIL BRKT CENTER LINE	
mm	Inches	mm	Inches	mm	Inches
1372	54	1467	57 3/4	733	28 7/8
1524	60	1619	63 3/4	810	31 7/8

Plan view – Prolift HD type 2 (48" x 60")

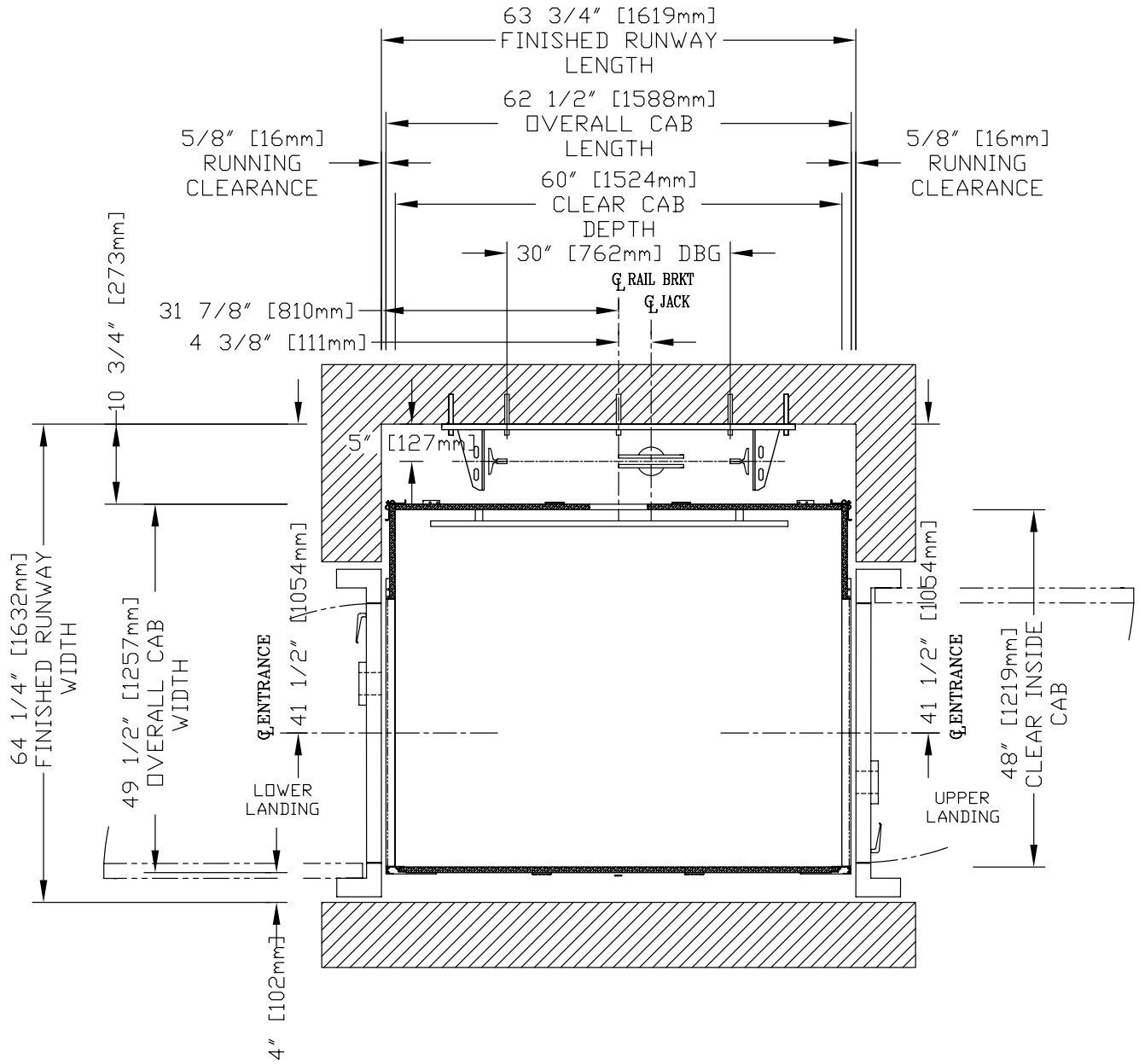

Plan view – Prolift HD type 3 (42" x 54", 42" x 60")

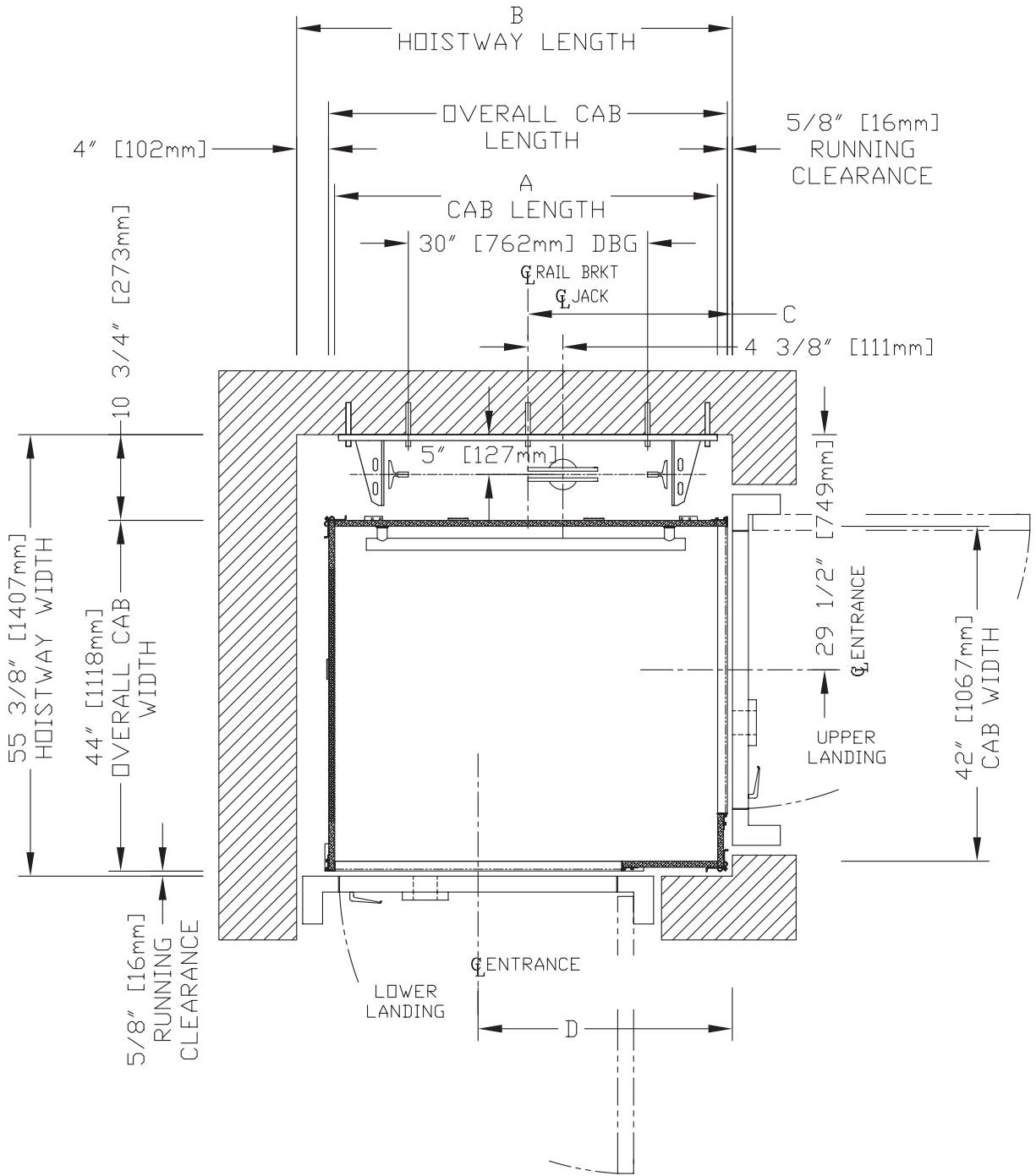

HOISTWAY DIMENSIONS

A CAB LENGTH		B HOISTWAY LENGTH		C RAIL BRKT CENTER LINE		D ENTRANCE CENTER LINE	
mm	Inches	mm	Inches	mm	Inches	mm	Inches
1372	54	1540	60 5/8	727	28 5/8	962	37 7/8
1524	60	1692	66 5/8	803	31 5/8	1114	43 7/8

Plan view – Prolift HD type 3 (48" x 60")

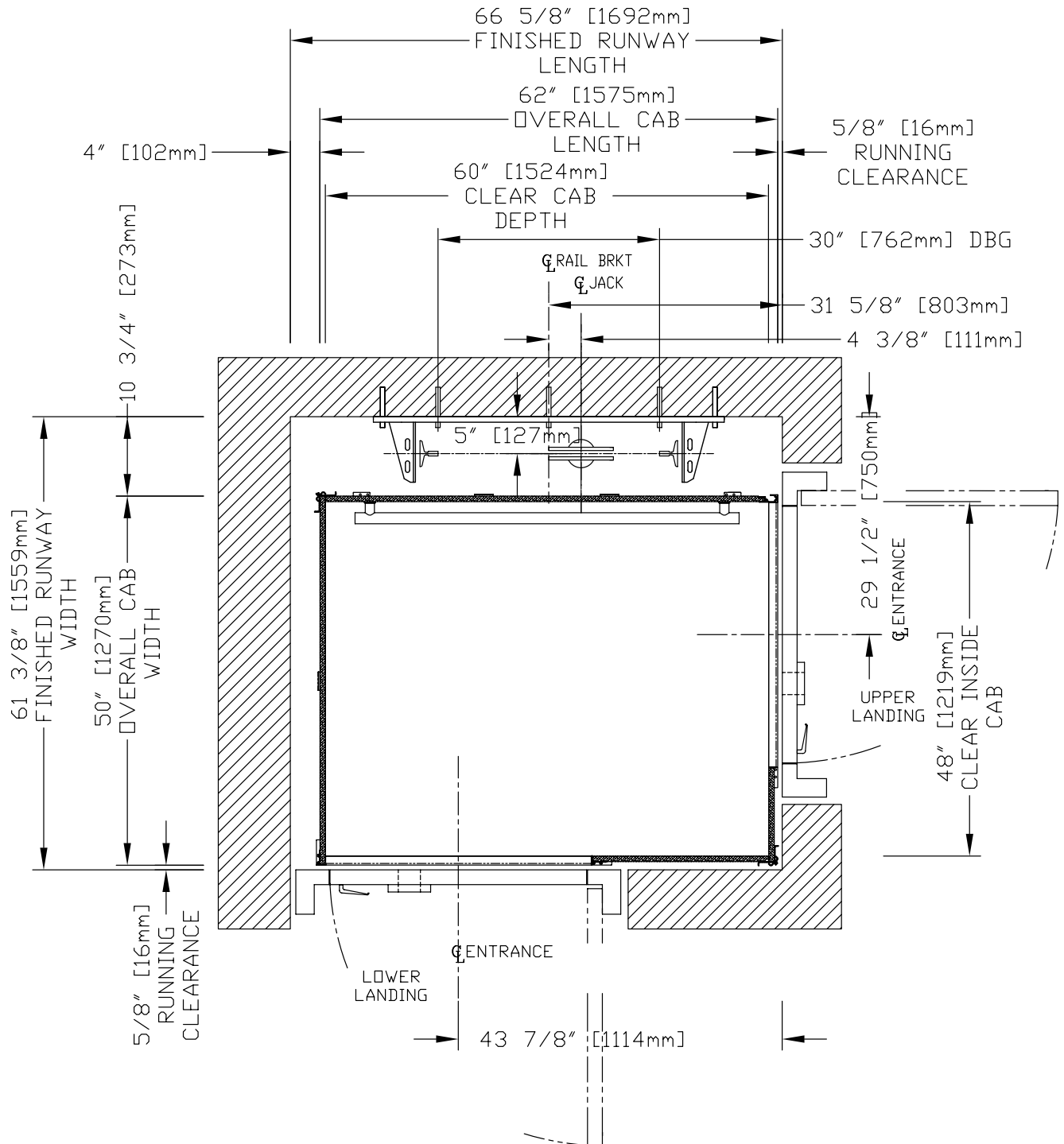

Plan view – Prolift HD type 3 – 42" B wall opening (42" x 54", 42" x 60")

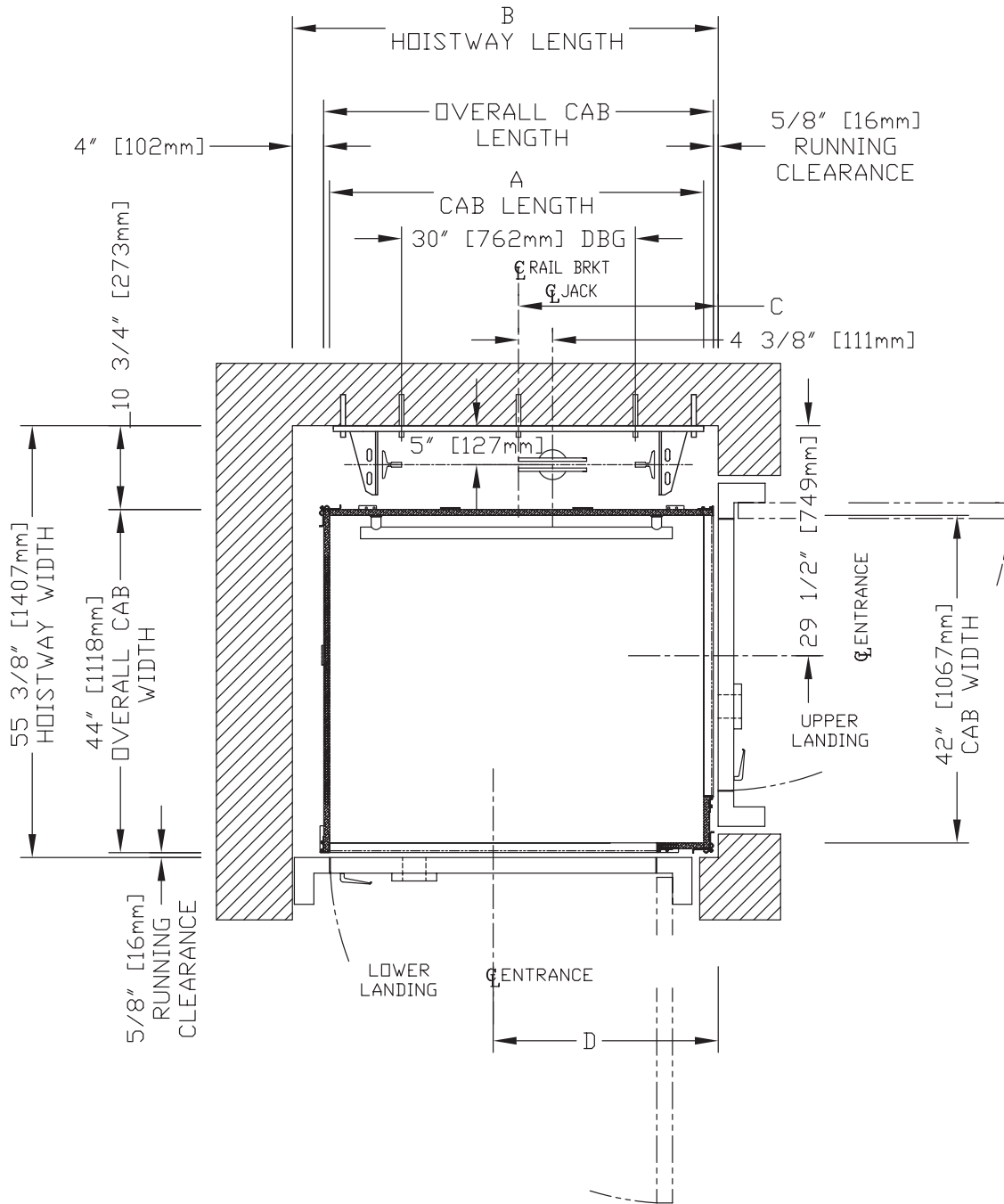

HOISTWAY DIMENSIONS

A CAB LENGTH		B HOISTWAY LENGTH		C RAIL BRKT CENTER LINE		D ENTRANCE CENTER LINE	
mm	Inches	mm	Inches	mm	Inches	mm	Inches
1372	54	1540	60 5/8	727	28 5/8	886	34 7/8
1524	60	1692	66 5/8	803	31 5/8	1038	40 7/8

Plan view – Prolift HD type 3 – 42" B wall opening (48" x 60")

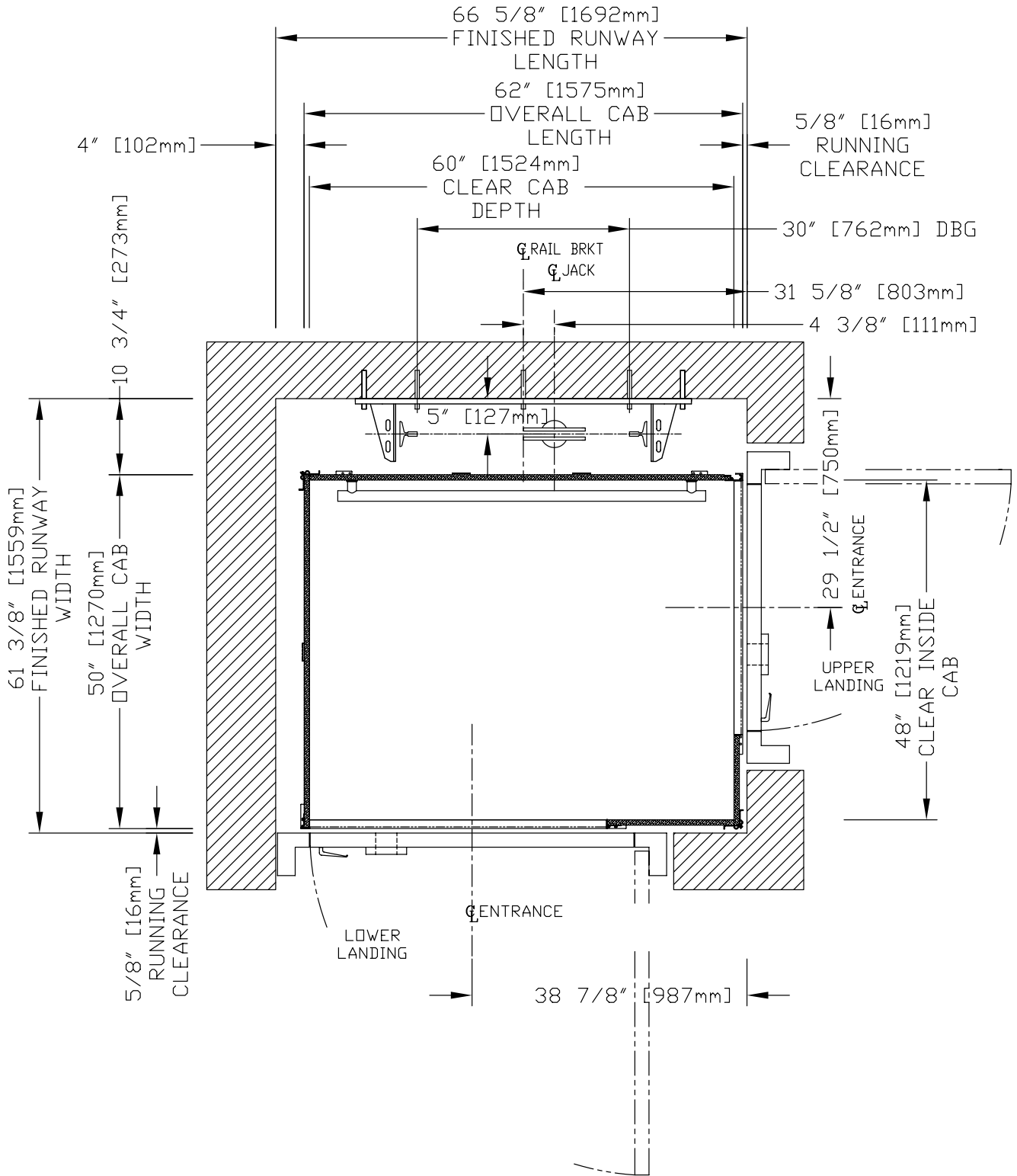

Plan view – Prolift HD type 4 (42" x 54", 42" x 60")

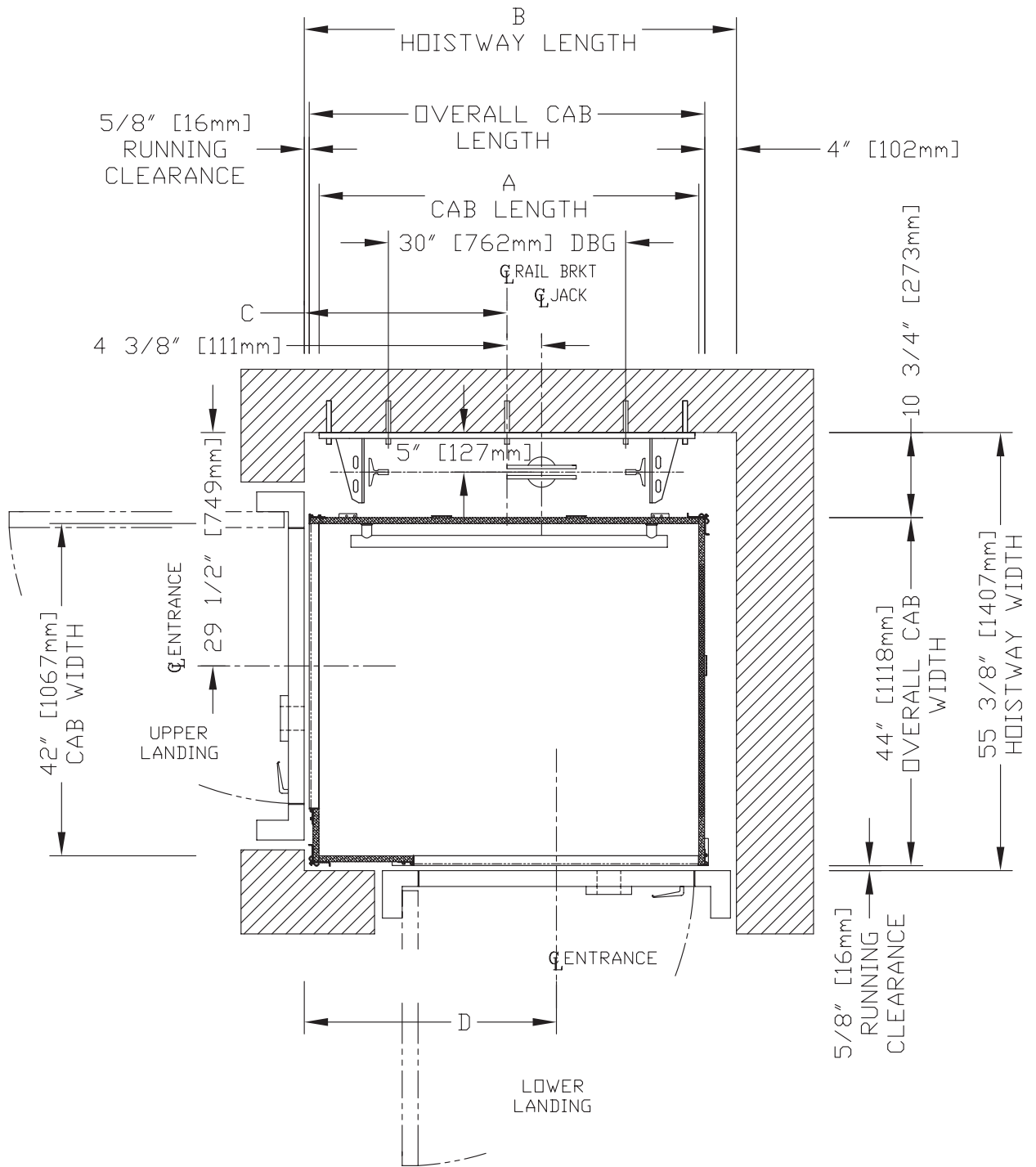

HOISTWAY DIMENSIONS

A CAB LENGTH		B HOISTWAY LENGTH		C RAIL BRKT CENTER LINE		D ENTRANCE CENTER LINE	
mm	Inches	mm	Inches	mm	Inches	mm	Inches
1372	54	1540	60 5/8	727	28 5/8	962	37 7/8
1524	60	1692	66 5/8	803	31 5/8	1114	43 7/8

Plan view – Prolift HD type 4 (48" x 60")

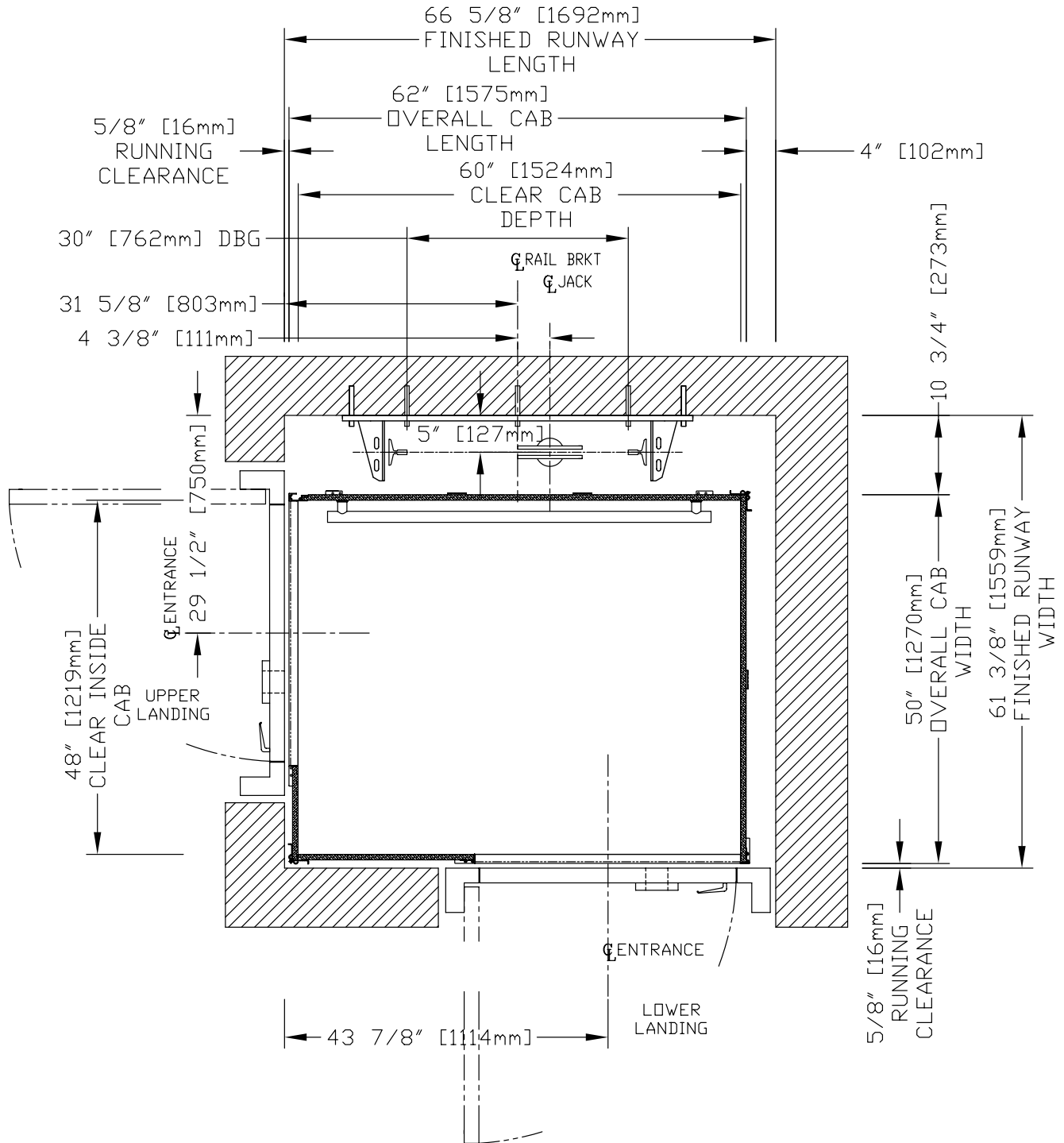

Plan view – Prolift HD type 4 – 42" B wall opening (42" x 54", 42" x 60")

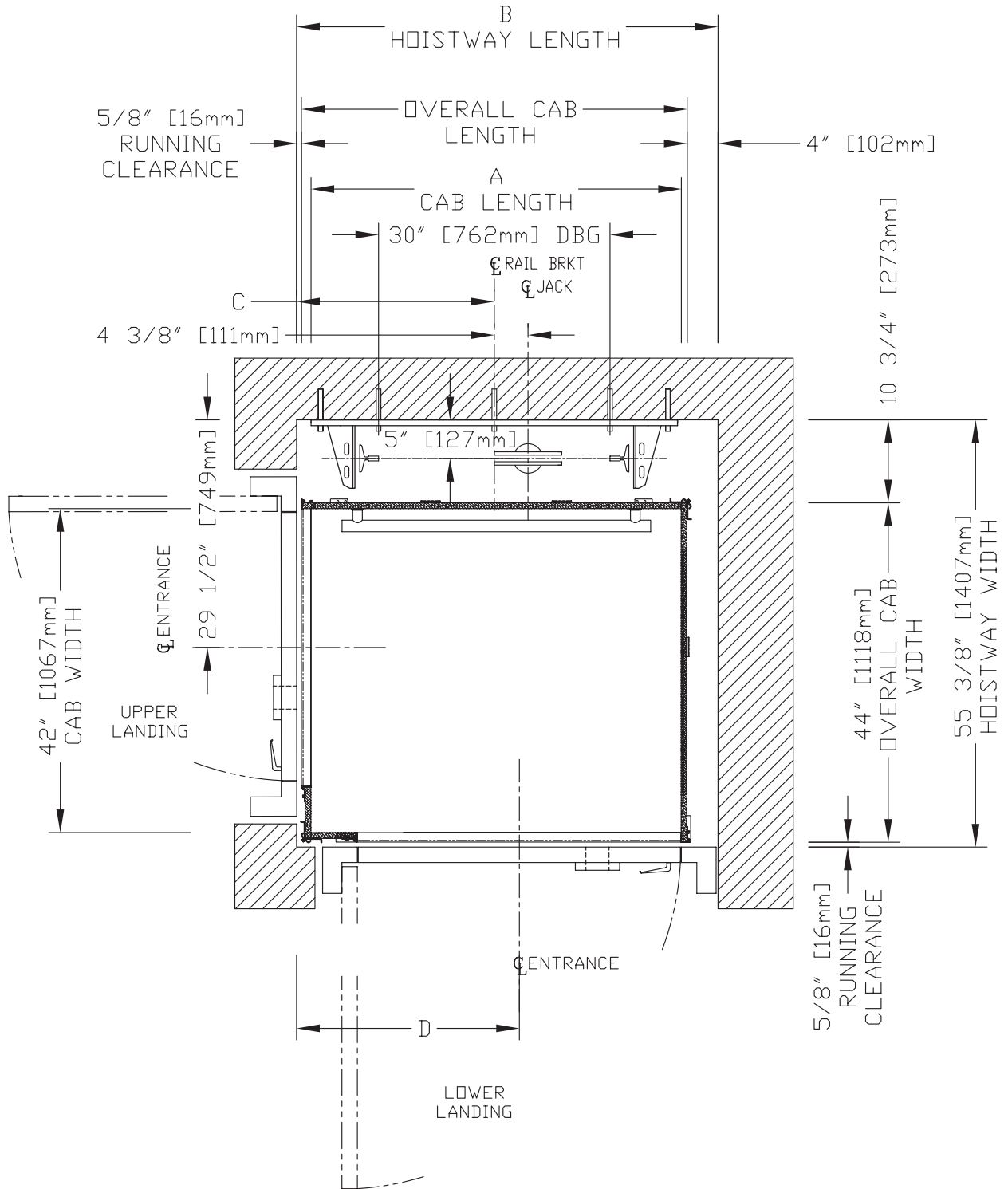

HOISTWAY DIMENSIONS

A CAB LENGTH		B HOISTWAY LENGTH		C RAIL BRKT CENTER LINE		D ENTRANCE CENTER LINE	
mm	Inches	mm	Inches	mm	Inches	mm	Inches
1372	54	1540	60 5/8	727	28 5/8	886	34 7/8
1524	60	1692	66 5/8	803	31 5/8	1038	40 7/8

Plan view – Prolift HD type 4 – 42" B wall opening (48" x 60")

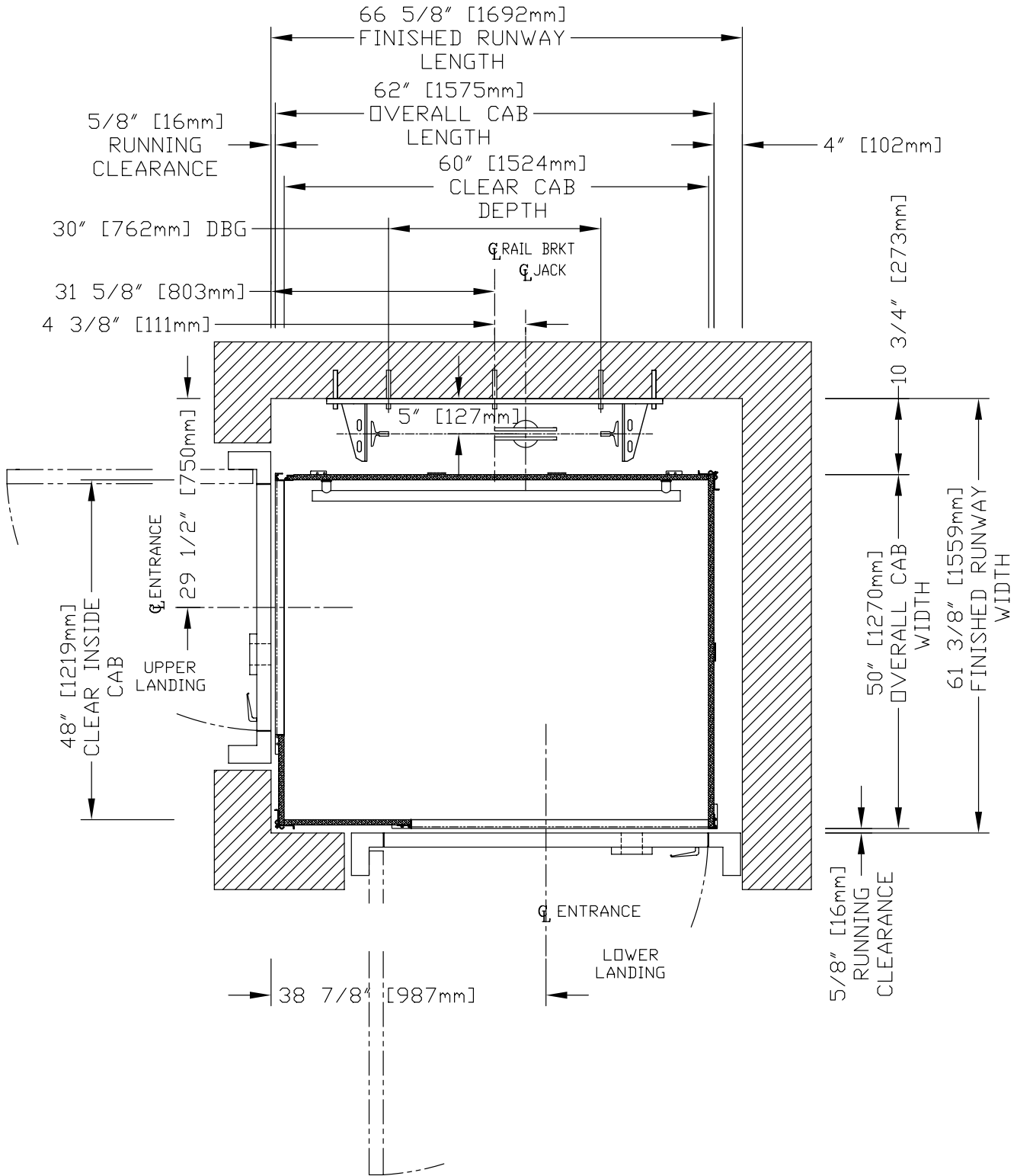

Plan view – Prolift HD type 5 (42" x 54", 42" x 60")

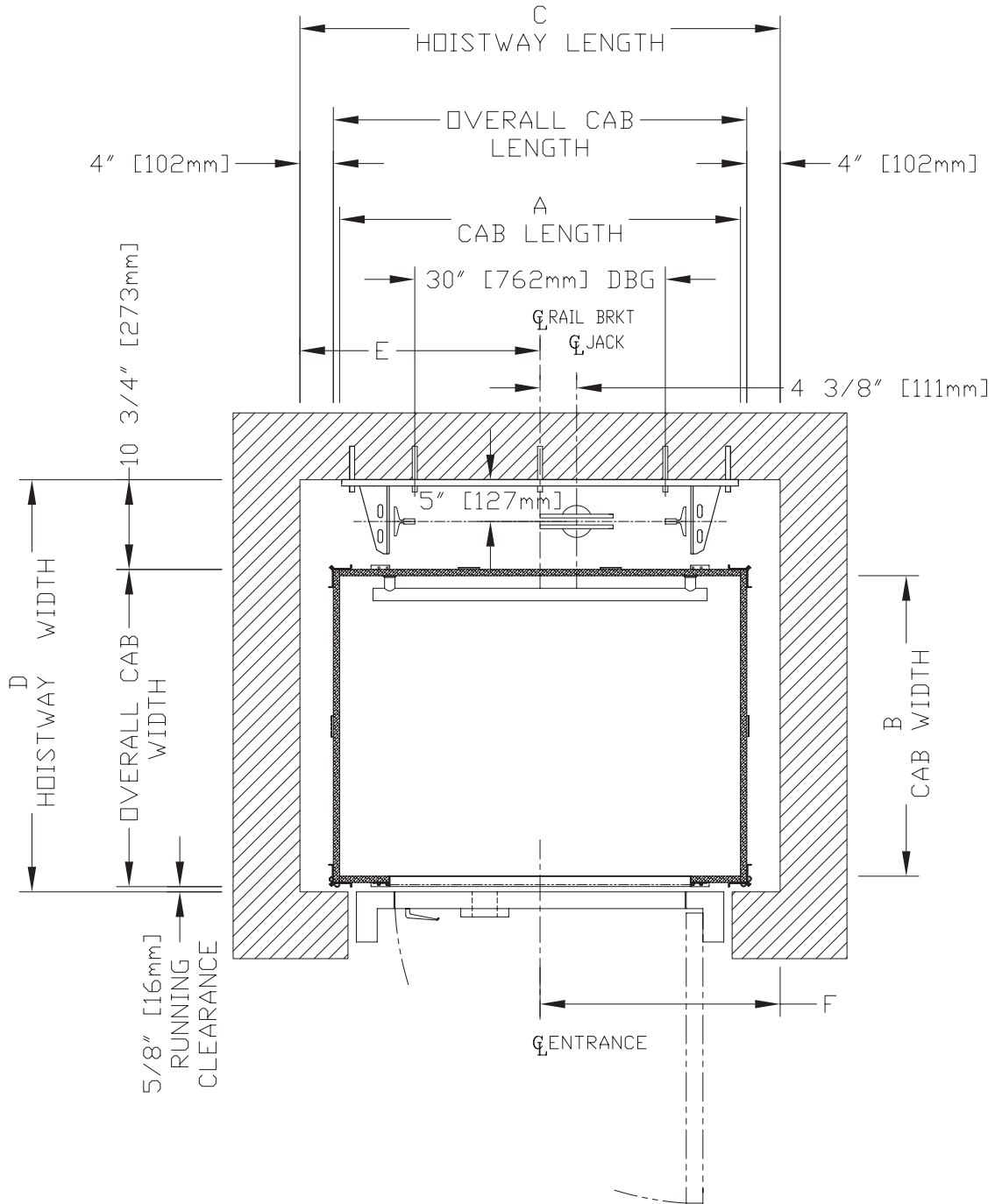

HOISTWAY DIMENSIONS

A CAB LENGTH		B CAB WIDTH		C HOISTWAY LENGTH		D HOISTWAY WIDTH		E RAIL BRKT CENTER LINE		F ENTRANCE CENTER LINE	
mm	Inches	mm	Inches	mm	Inches	mm	Inches	mm	Inches	mm	Inches
1372	54	1067	42	1613	63 1/2	1407	55 3/8	806	31 3/4	806	31 3/4
1524	60	1067	42	1765	69 1/2	1407	55 3/8	883	34 3/4	883	34 3/4

Plan view – Prolift HD type 5 (48" x 60")

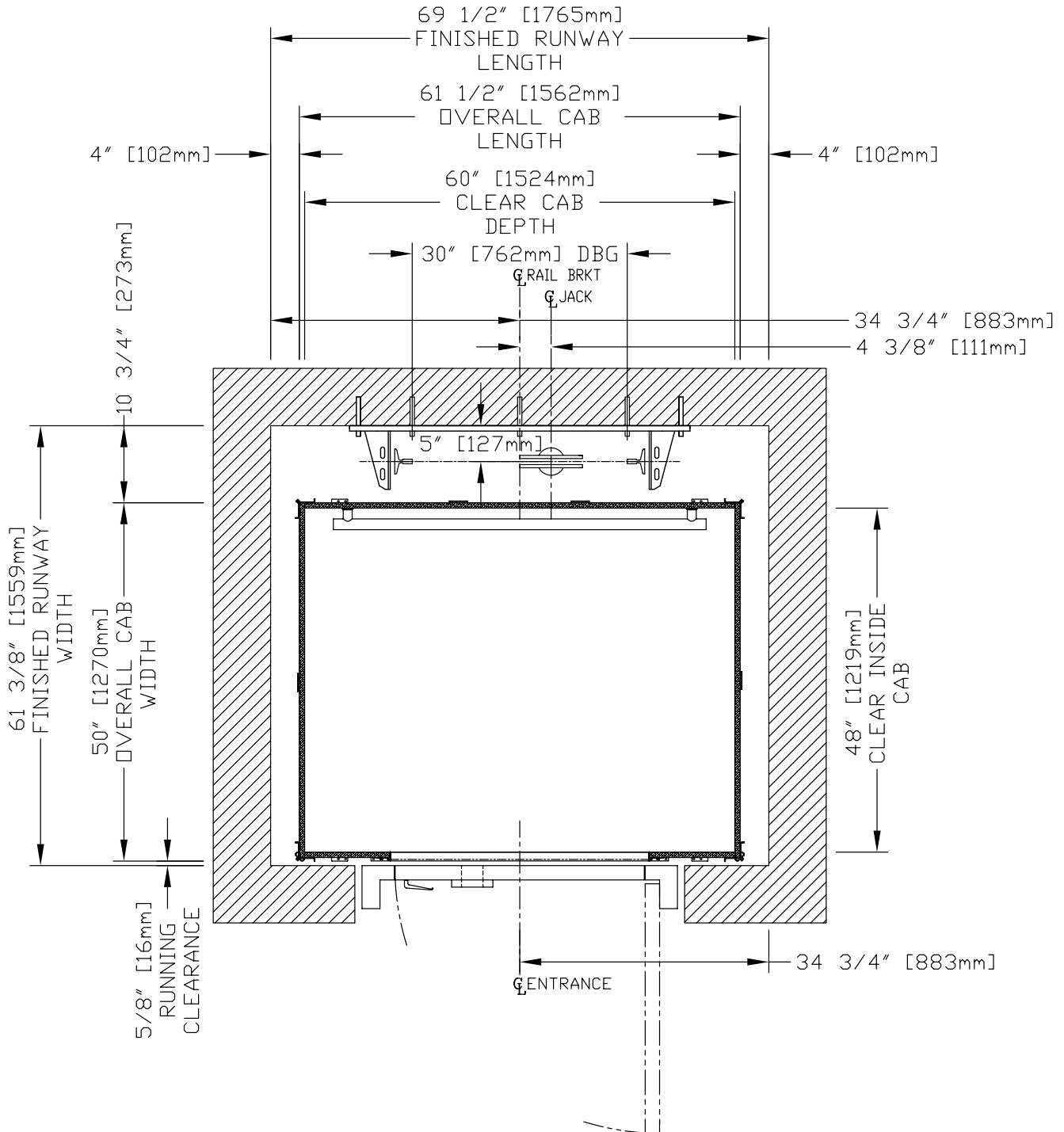

Door and gate specifications

For door and gate specifications, go to our website www.savaria.com, select the “architects and builders” tab at the top of the page and then select “Doors and Gates” from the menu on the left-hand side of the page.

The link is as follows: <http://www.savaria.com/architects/drawings/doors-gates/index.php>.

Loads on building

RAIL FORCES		
*R1	*R2	CAPACITY
422. lbf.	251.50lbf.	1400 lbs.
355.03lbf.	251.50lbf.	1000 lbs.
RAIL WEIGHT : 8.0 lbs / Ft		

R3 NOTE:	
PIT FLOOR TO SUPPORT LOAD OF: * (INCLUDES IMPACT)	
CAPACITY	
8.22 Kips	1400 lbs.
6.4 Kips	1000 lbs.

FOR TOTAL PULL-OUT FORCE ON RAIL BRACKET, R1 MUST BE DOUBLED eg. 608 lbf for 1000 lbs.

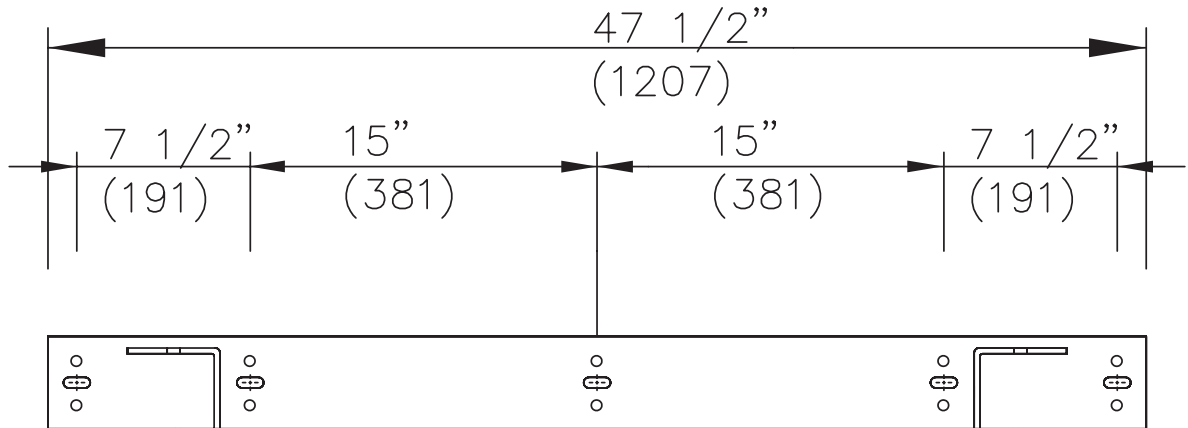
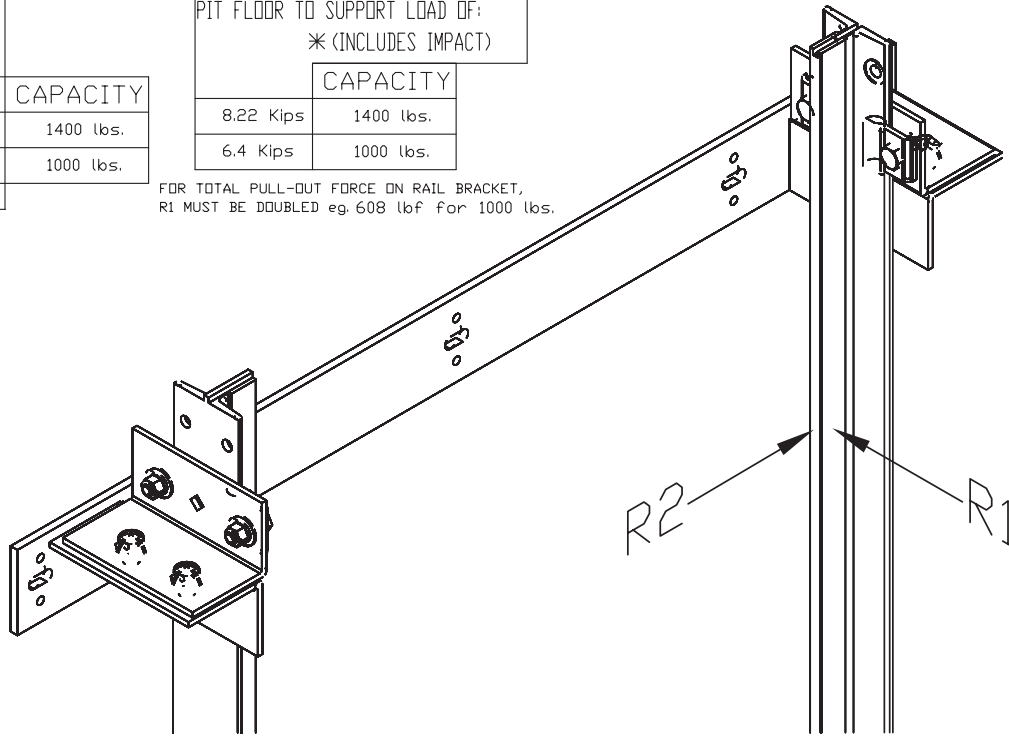

Rail bracket dimensions

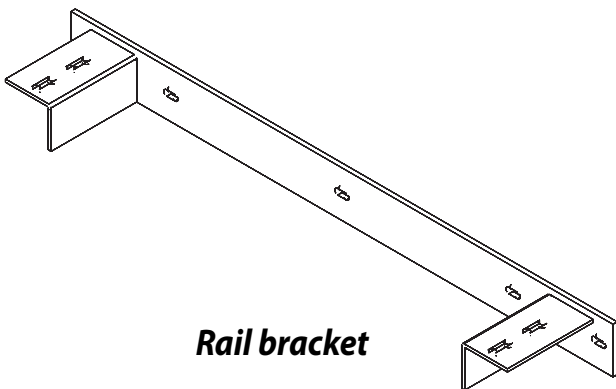

Rail bracket

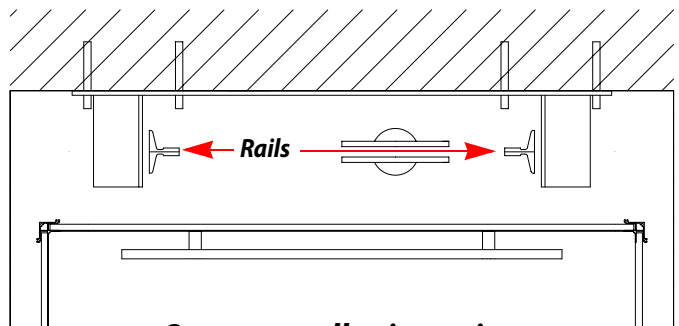

Support wall orientation

Pit details

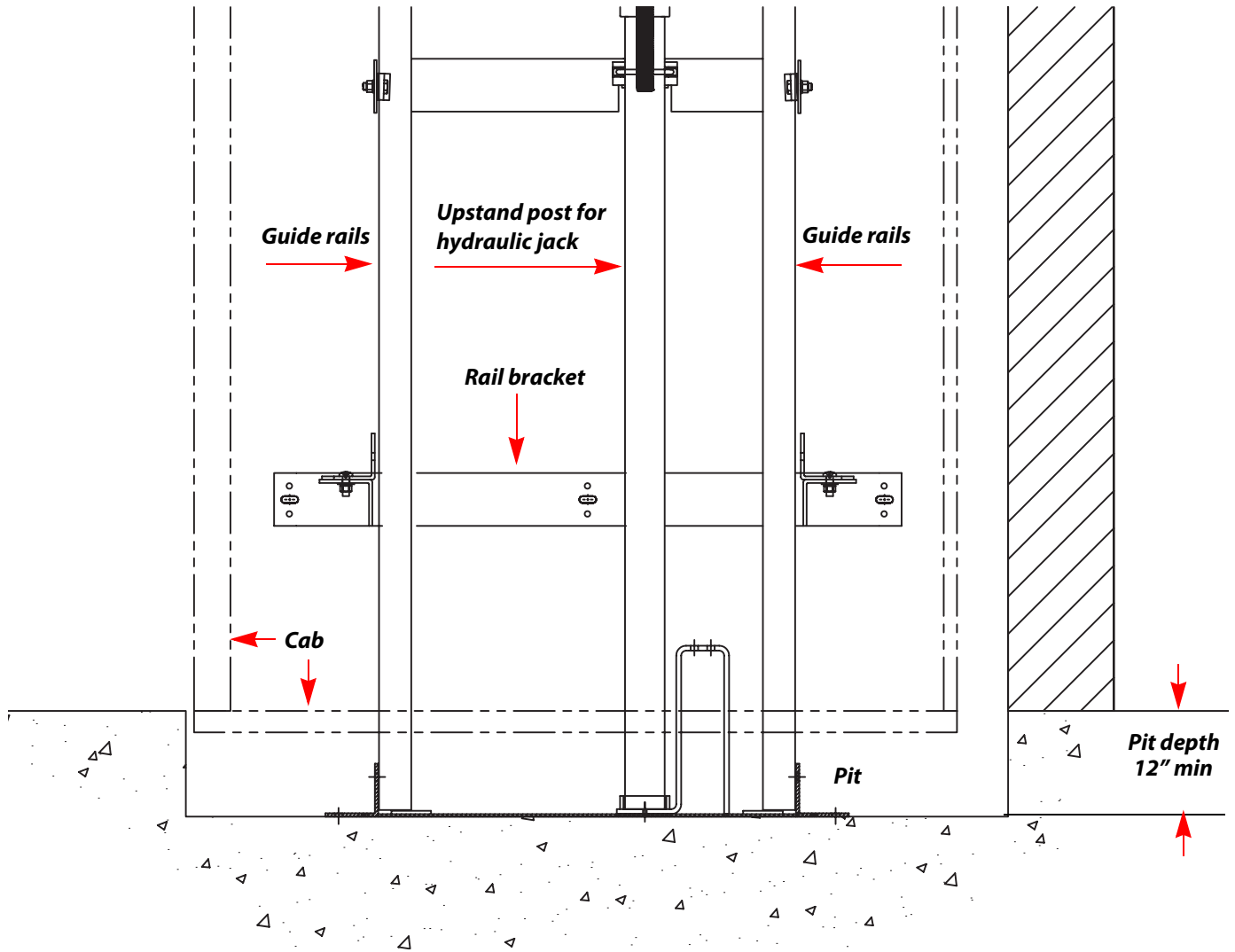

Masonry construction – sectional view

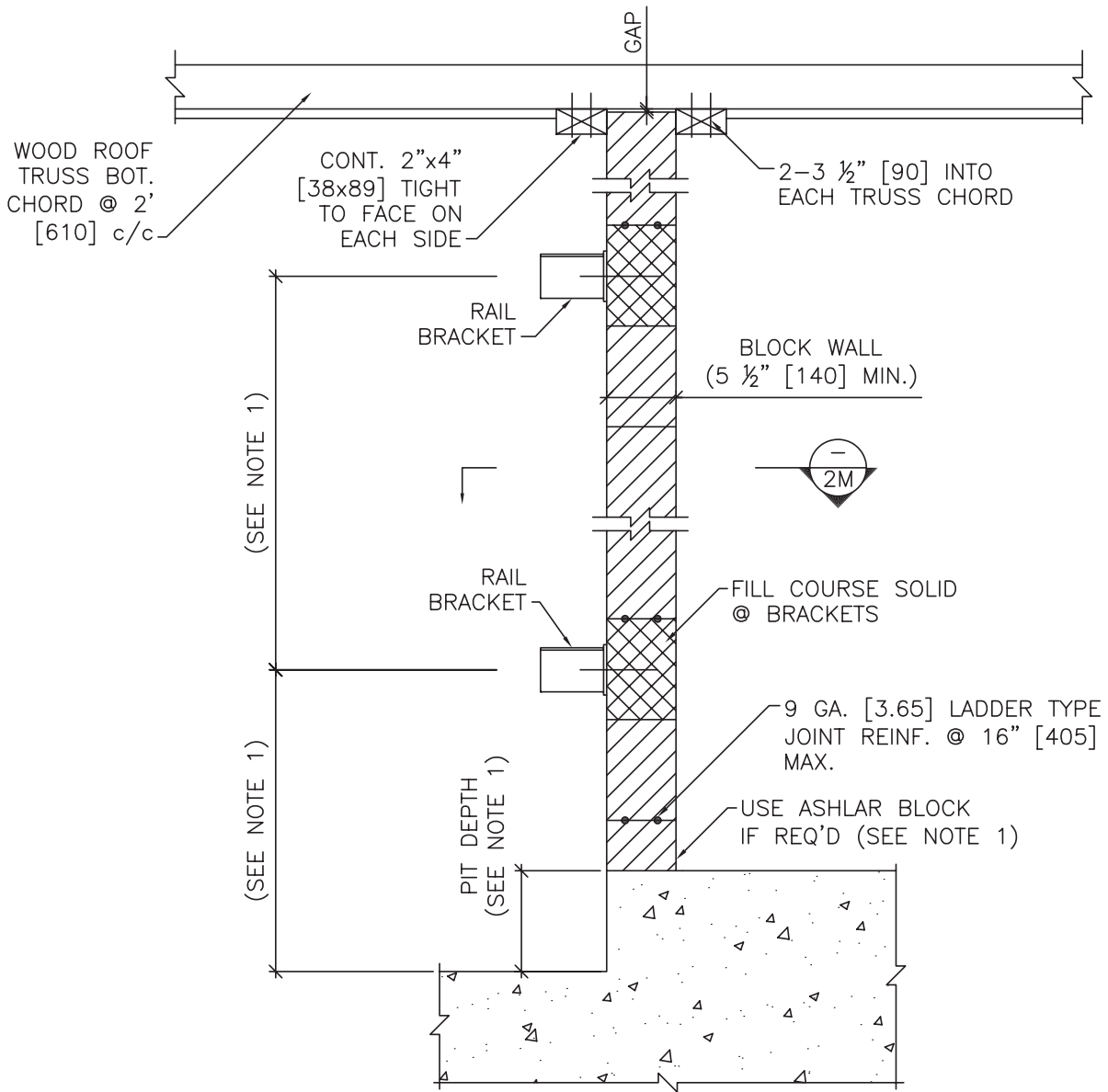

Masonry construction – plan view

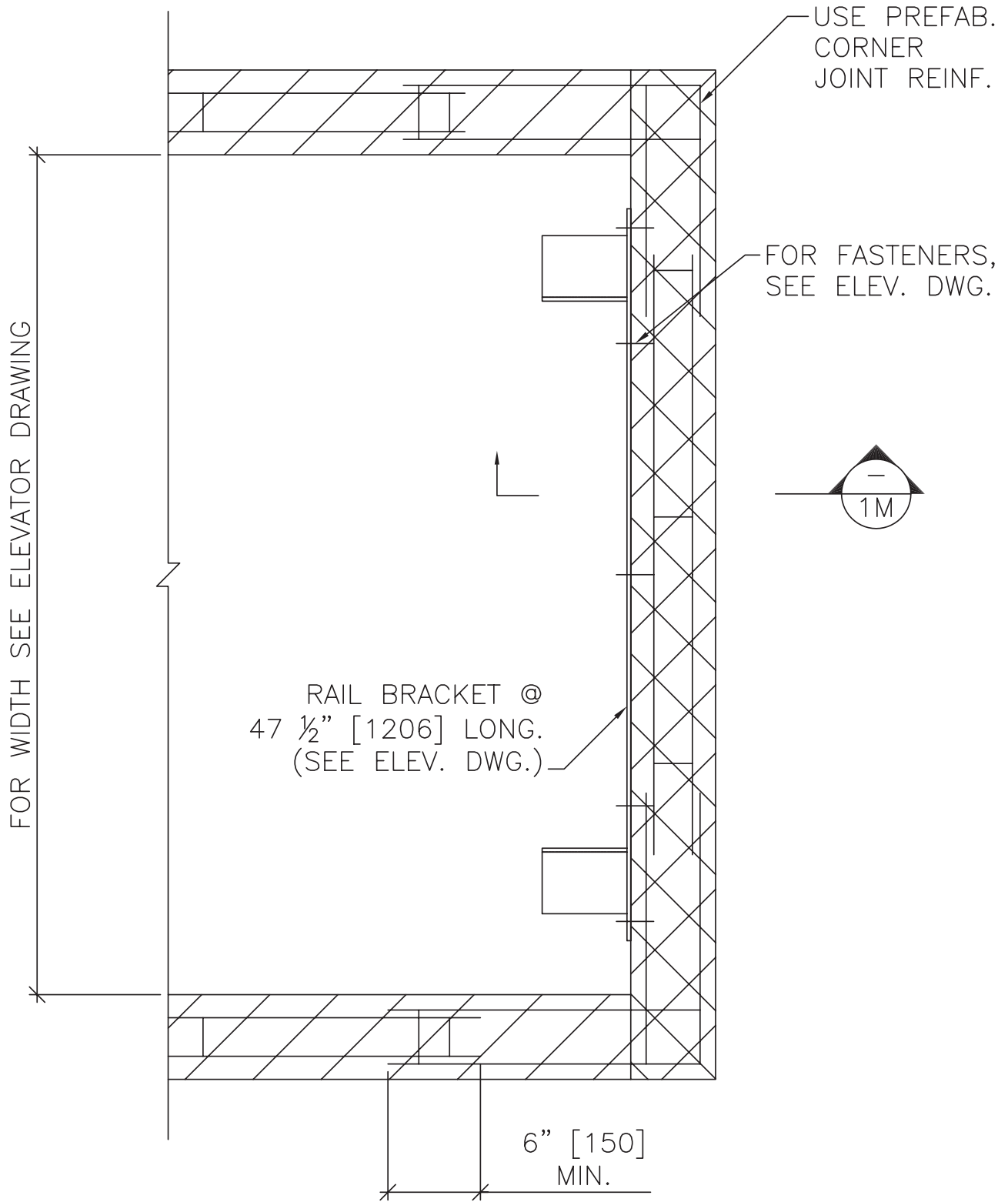

Wood construction – sectional view

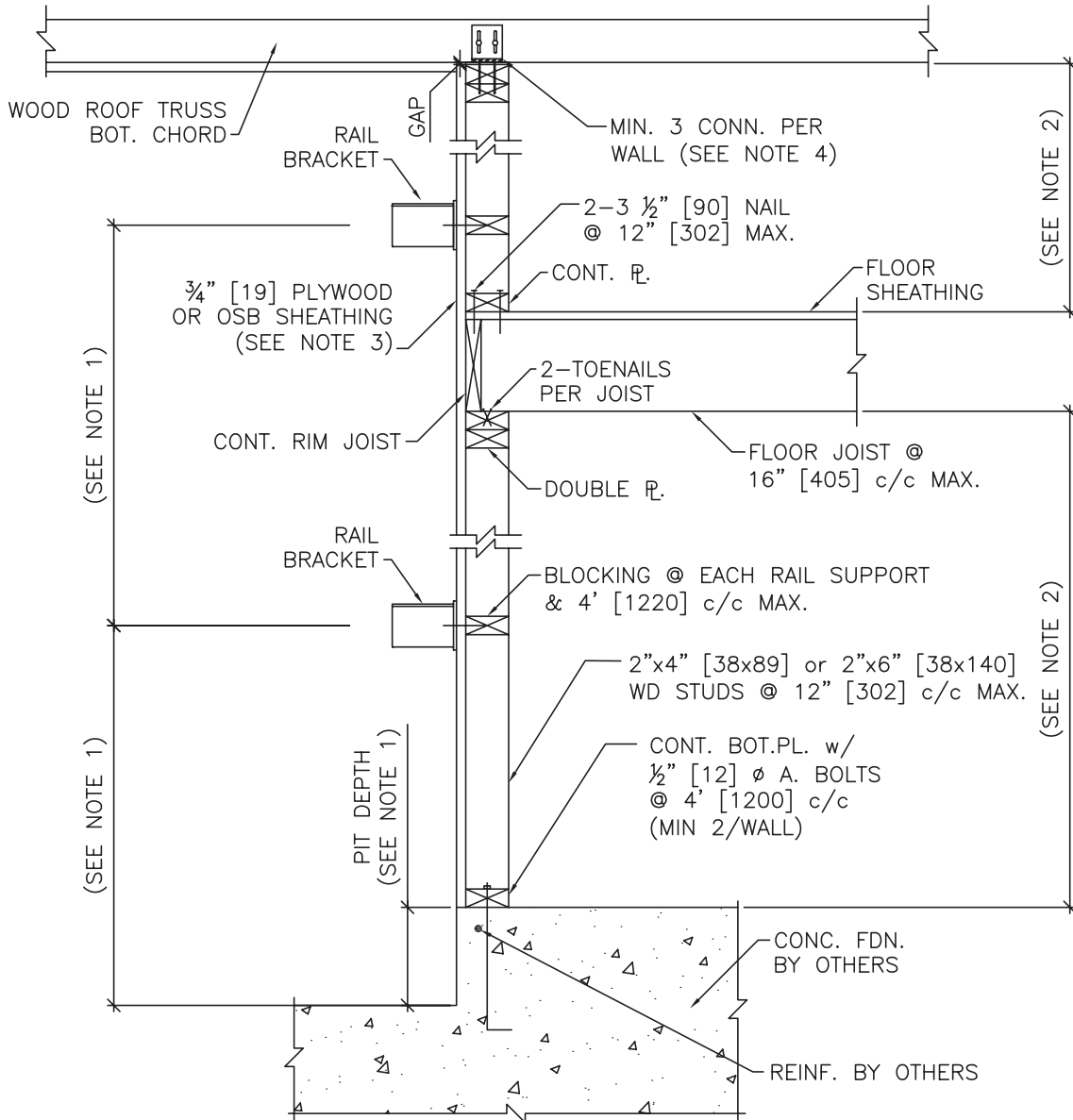

For Reference Only

Wood Stud Partitions (Load-Bearing) – 2-Hour Rating

<p>152 mm 6"</p> <p>wt. 59 kg/m² (12 PSF)</p>	<p>Wd Stud—2 layers 15.9 mm (5/8") SHEETROCK brand gypsum panels, FIRECODE core, or SHEETROCK brand gypsum panels, water-resistant, FIRECODE core, or SHEETROCK Vinyl-Faced Gypsum Panels, FIRECODE Core, ea side—2x4 400 mm (16") o.c.—base layer att with 48 mm (1 7/8") nails 150 mm (6") o.c.—face layer att with 60 mm (2 3/8") nails 200 mm (8") o.c.—joints fin—ULC Des U301, UL Des U301</p>	<p>N/A</p>	<p>SA924 SA928</p>	<p>101</p>
<p>152 mm 6"</p> <p>wt. 59 kg/m² (12 PSF)</p>	<p>Wd Stud—2 layers 15.9 mm (5/8") SHEETROCK brand gypsum panels, FIRECODE C core, ea side—2x4 400 mm (16") o.c.—76 mm (3") THERMAFIBER SAFB—RC-1 chan or equiv one side, spaced 600 mm (24") o.c.—resil side screw att—opp side nail att—both base layers appl vert and face layers appl horiz—resil layers perim caulked—joints fin—UL Des U334</p>	<p>59 TL-67-239</p>	<p>SA924</p>	<p>102</p>
<p>152 mm 6"</p> <p>wt. 63 kg/m² (13 PSF)</p>	<p>Wd Stud—2 layers 15.9 mm (5/8") SHEETROCK brand gypsum panels, FIRECODE C core, ea side—2x4 400 mm (16") o.c.—51 mm (2") THERMAFIBER SAFB—RC-1 chan or equiv one side, spaced 600 mm (24") o.c.—resil side screw att—opp side nail att—both base layers appl vert and face layers appl horiz—resil layers perim caulked—joints fin—UL Des U334</p>	<p>58 USG-810219 52 Based on same assembly (non-fire rated) without SAFB—USG-810218</p>	<p>SA924</p>	<p>103</p>

Wood construction – plan view

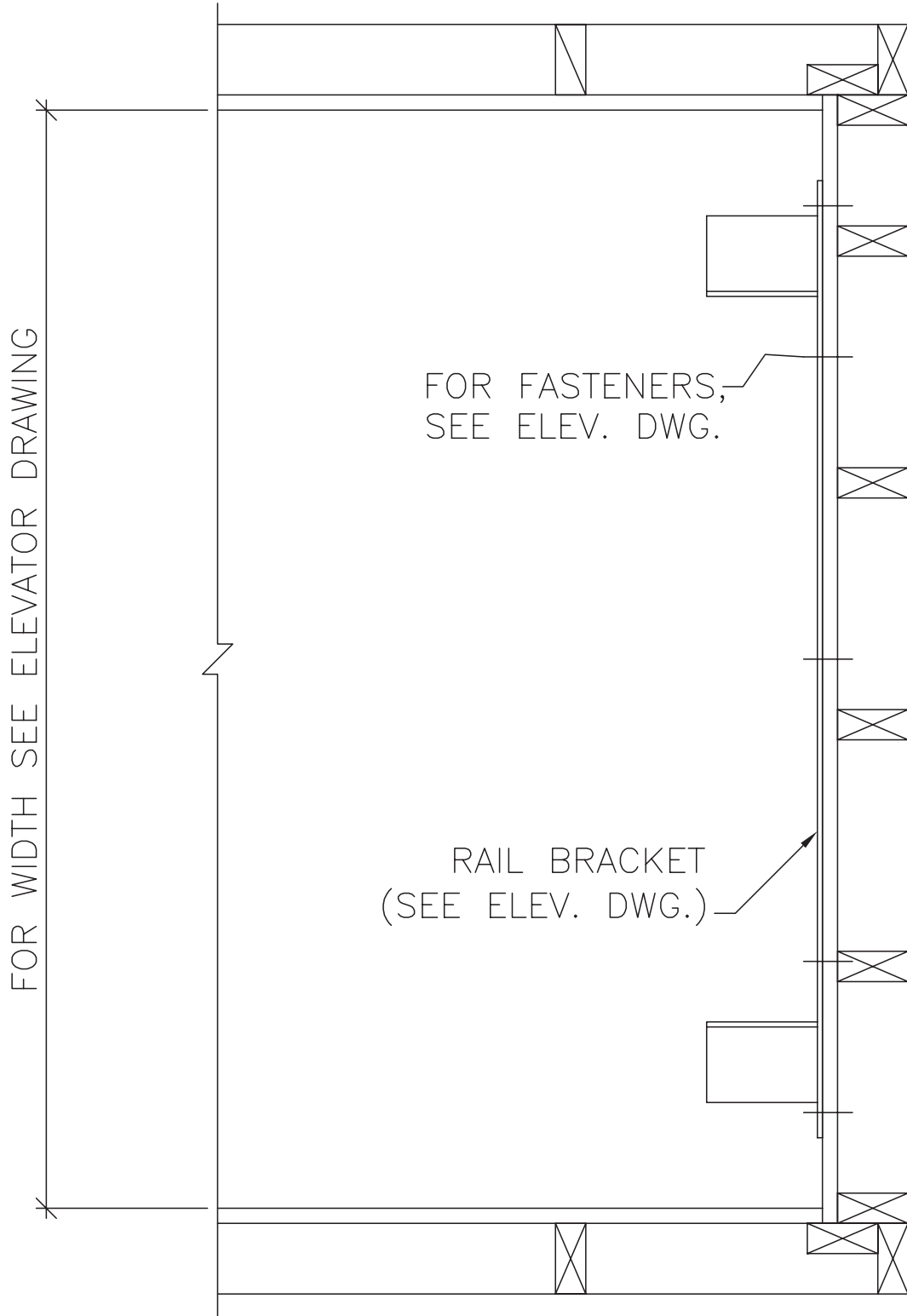

Suggested wall configuration for wood construction

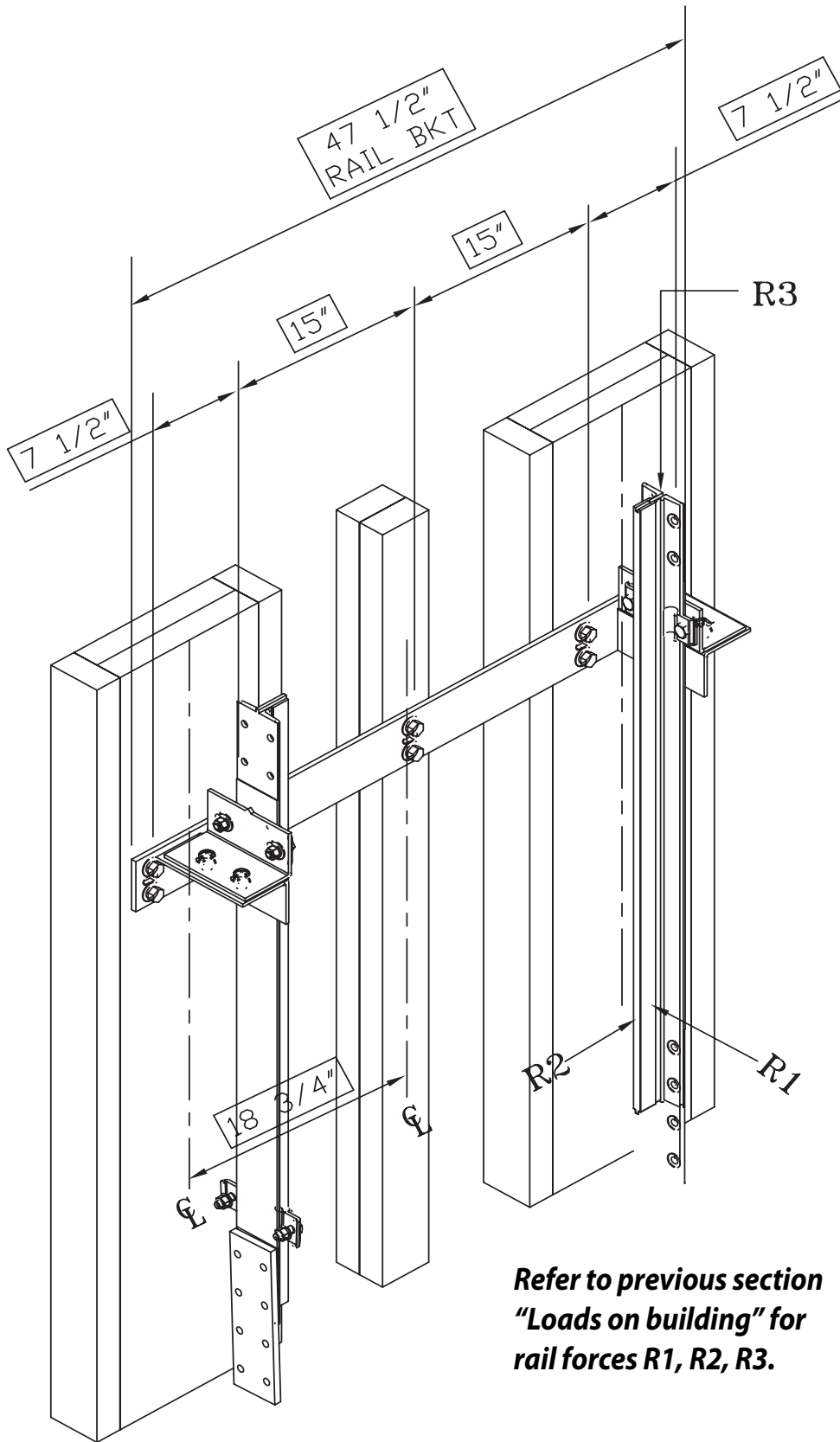

Suggested wall configuration for wood construction

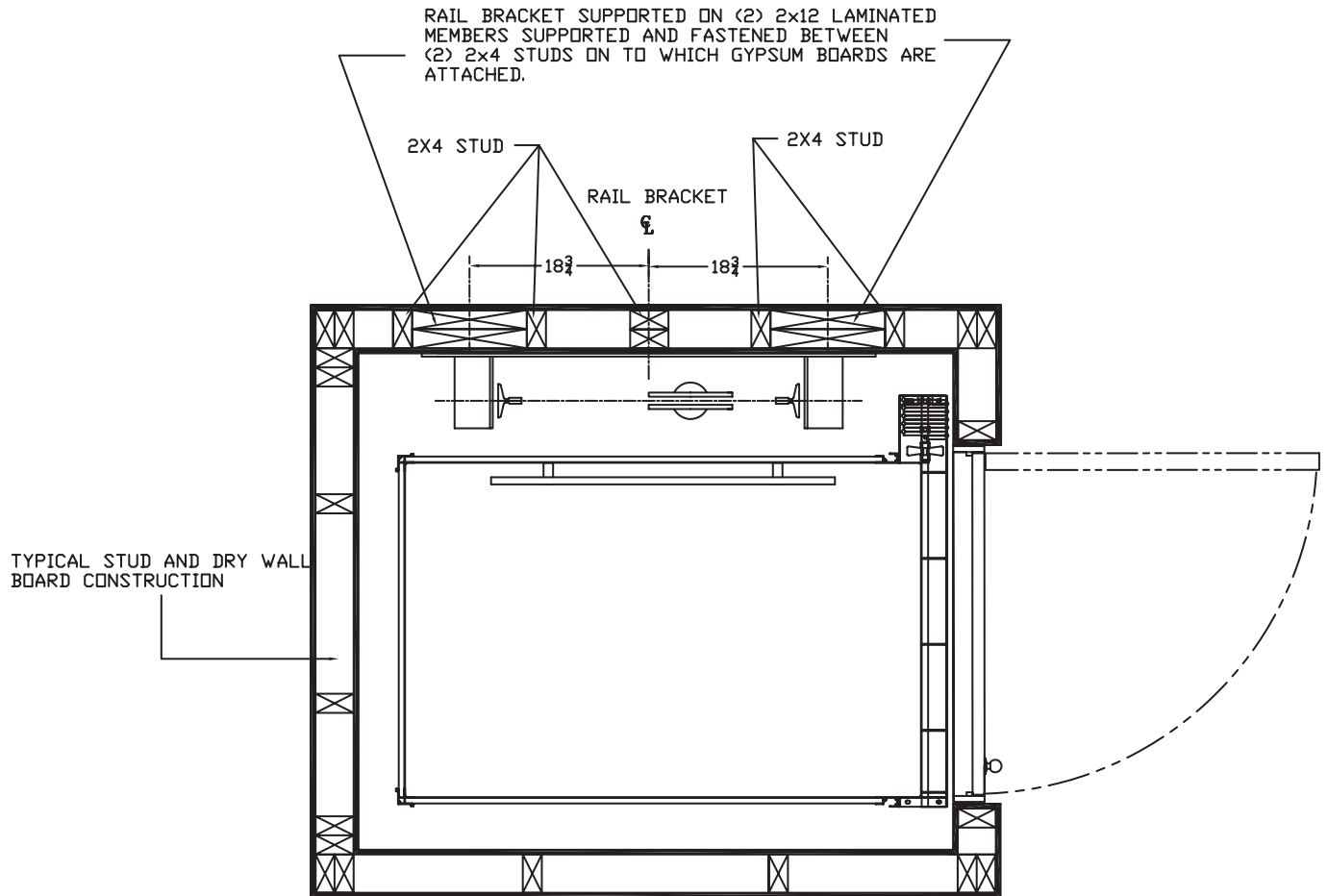

NOTE:

1. THIS DRAWING IS FOR REFERENCE ONLY. BUILDING STRUCTURAL ENGINEER TO ENSURE THAT THE BUILDING AND HOISTWAY WILL SAFELY SUPPORT ALL LOADS IMPOSED BY THE LIFT EQUIPMENT
2. FIRE RATING OF HOISTWAY IS SUBJECT TO LOCAL BUILDING CODES.

Rail support wall specifications

Drawing notes

- 1) See the lift installation (shop) drawings for rail bracket spacing and pit depth.
- 2) Wall lateral support spacing:
 - For 2" x 4" studs, use 6 ft 10" (2090 mm) max.
 - For 2" x 6" studs, use 13 ft 6" (4120 mm) max.
- 3) Sheathing installation: install sheets vertically full width of shaft or min. centred on rail brackets.
- 4) Connectors to resist horizontal load but allow vertical movement. For wood, use 2" x 1/4" cap screw lag bolts.

General specifications

- G1 The design and construction of all work is to conform to the local applicable building code.
- G2 Read the installation (shop) drawings in conjunction with all related architectural, mechanical, electrical, and lift drawings as well as any other contract documents.
- G3 The wall drawings have been prepared using engineering principles and the design loads that are applied by the lift rails to the wall. However, the details and member sizes and the attachments to the structure should not be construed as a complete design of the wall system.
The contractor and/or the project engineer is responsible to evaluate the other loads that are applied to the wall from the floor or roof system and modify member sizes or connections as required by their analysis.
- G4 Do not scale the drawings.
- G5 See the lift installation (shop) drawings for service loads (including dynamic effects) which are:
 - Horizontal load parallel to the wall
 - Horizontal load perpendicular to the wall
- G6 Wood: SPF NO 1/2 Mix
Concrete: 3000 psi (20 Mpa) @ 28 days. If exposed use 5% to 7% air content.
Anchor bolts: ASTM A307
Mortar: Type "S"
Masonry grout: 2100 psi (14 Mpa) high slump
Masonry block: 2100 psi (14 Mpa) on net area
- G7 Wall to be installed plumb and square within 1/8" (3 mm) of top and bottom of shaft.
- G8 Wall lateral support spacing (H) selected for maximum horizontal deflection of H/360 from rail loads.

Wood construction

- W1 Separate wood from concrete with waterproof barrier or use pressure treated wood.
- W2 Bridging maximum spacing: Load bearing or shear walls – 4 ft c/c
- W3 Nail or screw sheathing at 6" c/c at edges and 12" c/c to other members.
Use 2.5" standard Ardox nails or 2" #12 screws.

Masonry construction

- M1 All masonry construction to conform to applicable local standards
- M2 Reinforce lintel blocks with 2 m-15 m bottom bars unless noted.
- M3 Provide continuous ladder type joint reinforcement at 16" (400) c/c.

Provisions by others

Hoistway

- The hoistway must be designed and built in accordance with all applicable codes (identified on the cover of this manual) and all state and local codes.
- Due to close running clearances, owner/agent must ensure that hoistway and pit (where provided) are level, plumb and square and are in accordance with the dimensions on the installation drawings.

Minimum overhead clearance

- Owner/agent must ensure minimum overhead clearance is in compliance with codes.

Construction site

- Owner/agent to provide all masonry, carpentry and drywall work as required and shall patch and make good (including finish painting) all areas where walls/floors may need to be cut, drilled or altered in any way to permit the proper installation of the lift.

Dimensions

- Contractor/customer to verify all dimensions and report any discrepancies to our office immediately.

Structural

- Structural engineer to assure that building and shaft will safely support all loads imposed by the lift equipment. Refer to the tables on installation drawings for loads imposed by the equipment.
- Entrance assemblies must be adjusted to align with platform and interlock equipment. Others to allow an adequate rough opening.
- Return walls at entrances must be built-in by others after entrance assemblies are in place. Entrance assembly must be securely fastened to walls by elevator contractor.

Entrances

- Fascia panel below upper level entrance where required. Fascia panel must be fastened to a solid wall and be perpendicular to the floor and walls. Hoistway fascia is not self-supporting for long, continuous runs void of entrances. Adequate support for the fascia must be provided.

Machine room

- Machine room must be located at the lowest level adjacent to hoistway, unless shown otherwise on the installation drawings. Field adjustment by installer may be necessary to meet job site conditions or regulations. Access to machine room to be through self-closing lockable door.
- Sleeves for oil and electric lines must be provided from machine room to runway as required (positioned per installer's instructions).

Electrical

- Power supply with a lockable fused disconnect and auxiliary contact to break the battery feed, or circuit breakers with a 3-pole breaker for battery feed required, in compliance with electrical code, located on wall on lock jamb side of machine room door. Contact your Savaria dealer or refer to one of the tables on the next page for OEM part numbers.
- Permanent power of 208 volts, three-phase, 30 amps or 230 volts, single-phase, 40 amps must be supplied by others before installation begins.
- Owner/agent to ensure at least 9.3 foot-candles (100 lux) ambient lighting over lift area.
- Remote hall call (when supplied) to be installed by the owner/agent at 42" from landing floor.

For Prolift SCL (3 HP pump unit)

Disconnect Switch Types & Accessories	Cutler Hammer	Federal Pioneer	Siemens
1 Phase 3 H.P. Pump Unit			
2 Pole Solid Neutral 208 or 230V 1 PH	1HD221N	1322SN	ID321
Required Auxiliary Contact	DS16CP	E1K-1AEV-W94	MSSAK 116
Required Type "D" Fuse (Buss type "FRN" or equal)	2@20 amp	2@20 amp	2@20 amp
3 Phase 3 H.P. Pump Unit			
3 Pole Solid Neutral 208V 3 PH	1HD321N	1332SN	ID321
Required Auxiliary Contact	DS16CP	E1K-1AEV-W94	MSSAK 116
Required Type "D" Fuse (Buss type "FRN" or equal)	3@15 amp	3@15 amp	3@15 amp
Cab Lighting			
1 Pole Solid Neutral 120V 1 PH	GP 111N	86211	CFN 211
Required Type "D" Fuse (Buss type "T" or equal)	1@15 amp	1@15 amp	1@15 amp

For Prolift HD (5 HP pump unit)

Disconnect Switch Types & Accessories	Cutler Hammer	Federal Pioneer	Siemens
1 Phase 5 H.P. Pump Unit			
2 Pole Solid Neutral 208 or 230V 1 PH	1HD221N	1322SN	ID321
Required Auxiliary Contact	DS16CP	E1K-1AEV-W94	MSSAK 116
Required Type "D" Fuse (Buss type "FRN" or equal)	2@40 amp	2@40 amp	2@40 amp
3 Phase 5 H.P. Pump Unit			
3 Pole Solid Neutral 208V 3 PH	1HD321N	1332SN	ID321
Required Auxiliary Contact	DS16CP	E1K-1AEV-W94	MSSAK 116
Required Type "D" Fuse (Buss type "FRN" or equal)	3@30 amp	3@30 amp	3@30 amp
Cab Lighting			
1 Pole Solid Neutral 120V 1 PH	GP 111N	86211	CFN 211
Required Type "D" Fuse (Buss type "T" or equal)	1@15 amp	1@15 amp	1@15 amp



107 Alfred Kuehne Blvd.
Brampton, ON Canada L6T 4K3
Phone: 905-791-5555
Fax: 905-791-2222
Sales: 800-661-5112
www.savaria.com